

NATIONAL HISTORIC SITES SERVICE

MANUSCRIPT REPORT NUMBER 46

EXCAVATIONS AT CASTLE HILL

by

Roger T. Grange, Jr.

VOLUME 7

September 1971

NATIONAL AND HISTORIC PARKS BRANCH

DEPARTMENT OF INDIAN AFFAIRS AND NORTHERN DEVELOPMENT

Excavations at Castle Hill

by

Roger T. Grange, Jr.

This is volume 7 of 7 volumes

1911

Figure 75. Olive jars, restorable vessel.
Vessel number 27. Scale in cm.

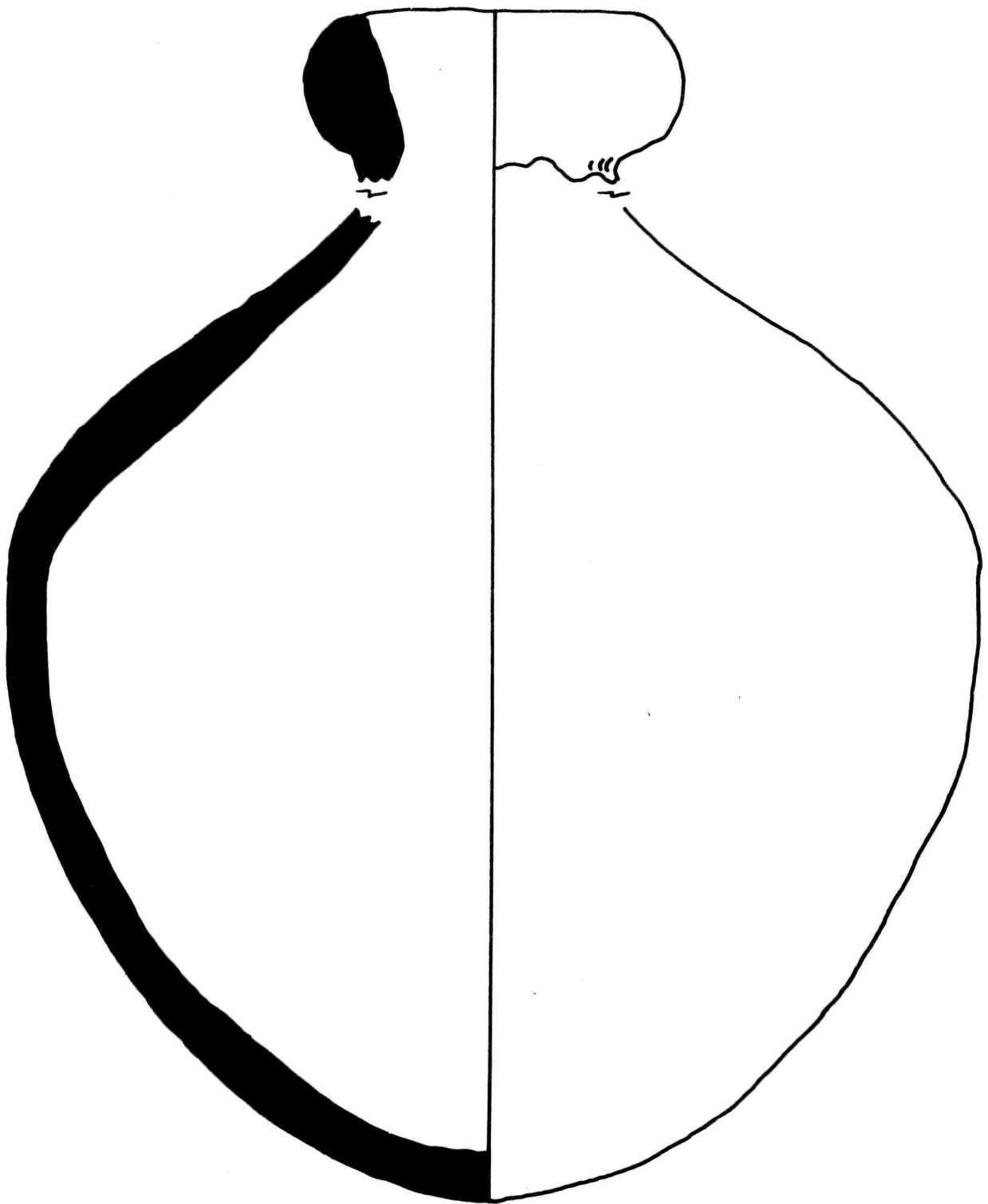

CM.

Figure 76. Olive jar vessel profiles. (a) shoulder, vessel number 31, (b) lower vessel wall, vessel number 32, (c) shoulder, vessel number 12, (d) vessel base, vessel number 52, (e) vessel base, vessel number 12, (f) vessel base, vessel number 32 (g) partially restorable vessel, vessel number 2. Scale in cm.

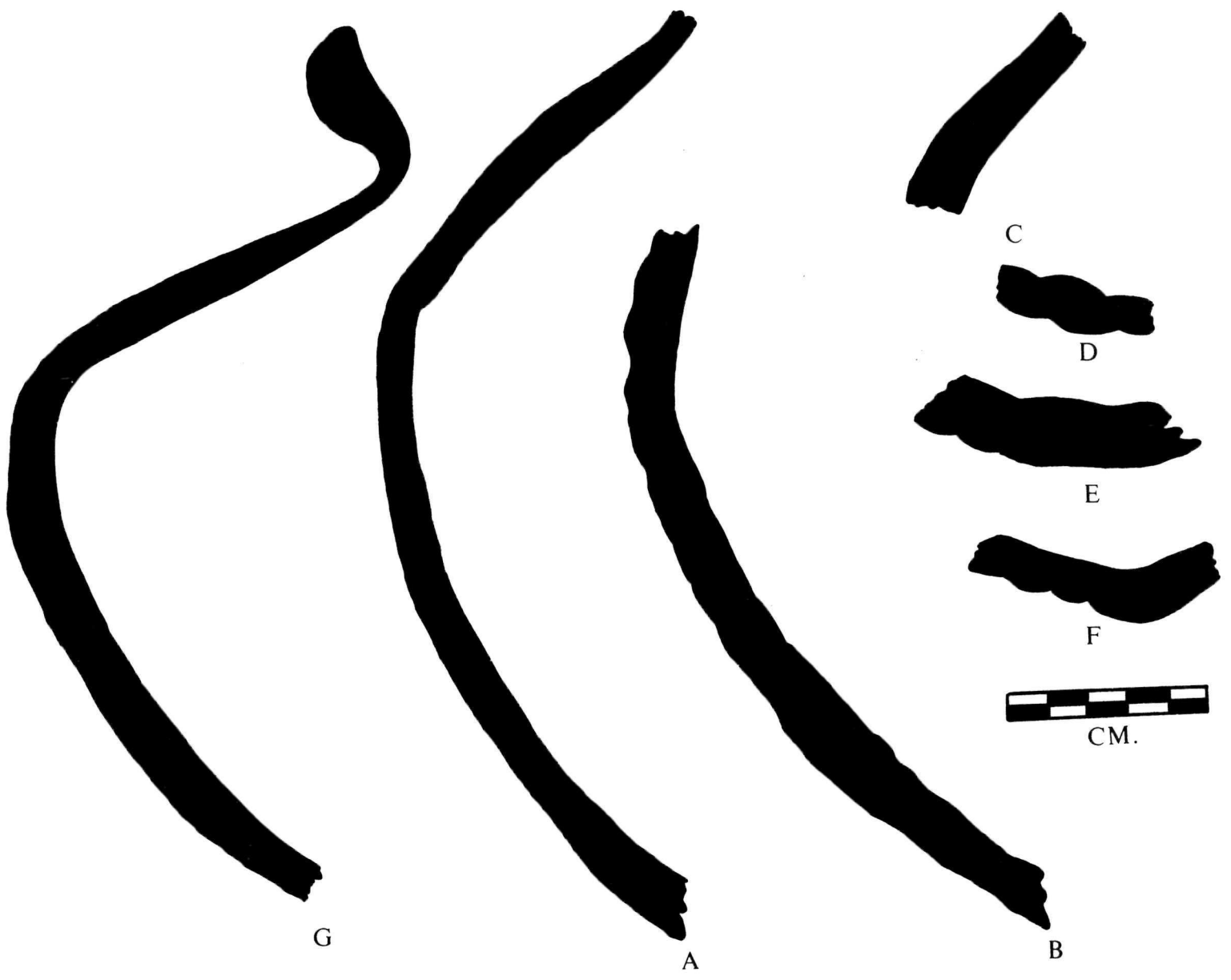

G

A

B

C

D

E

F

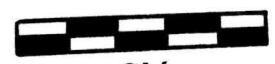

CM.

Figure 77. Olive jars, rim forms and base exterior, a-h vessel rims, i. exterior of vessel base showing spiral groove. (a) vessel 33, (b) vessel 35, (c) vessel 38, (d) vessel 37, (e) vessel 25, (f) vessel 5, (g) vessel 36, (h) vessel 34, (i) vessel 12. Scale in cm.

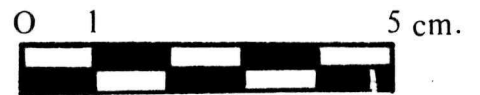
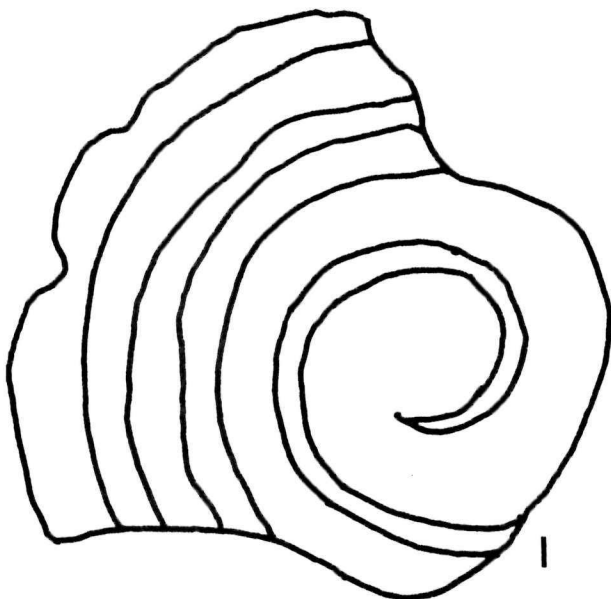
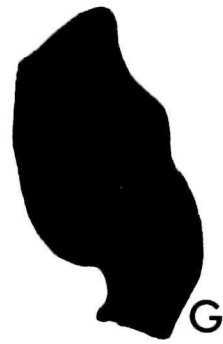

Figure 78. Coarse earthenwares. a-g white
paste, h-o pink paste. Vessel numbers: (a-d)
67, (e) 66, (f) 62, (g) 68, (h) 73, (i) 72,
(j,k) 76, (l) 82, (m) 84, (n,o) 72. Scale in cm.

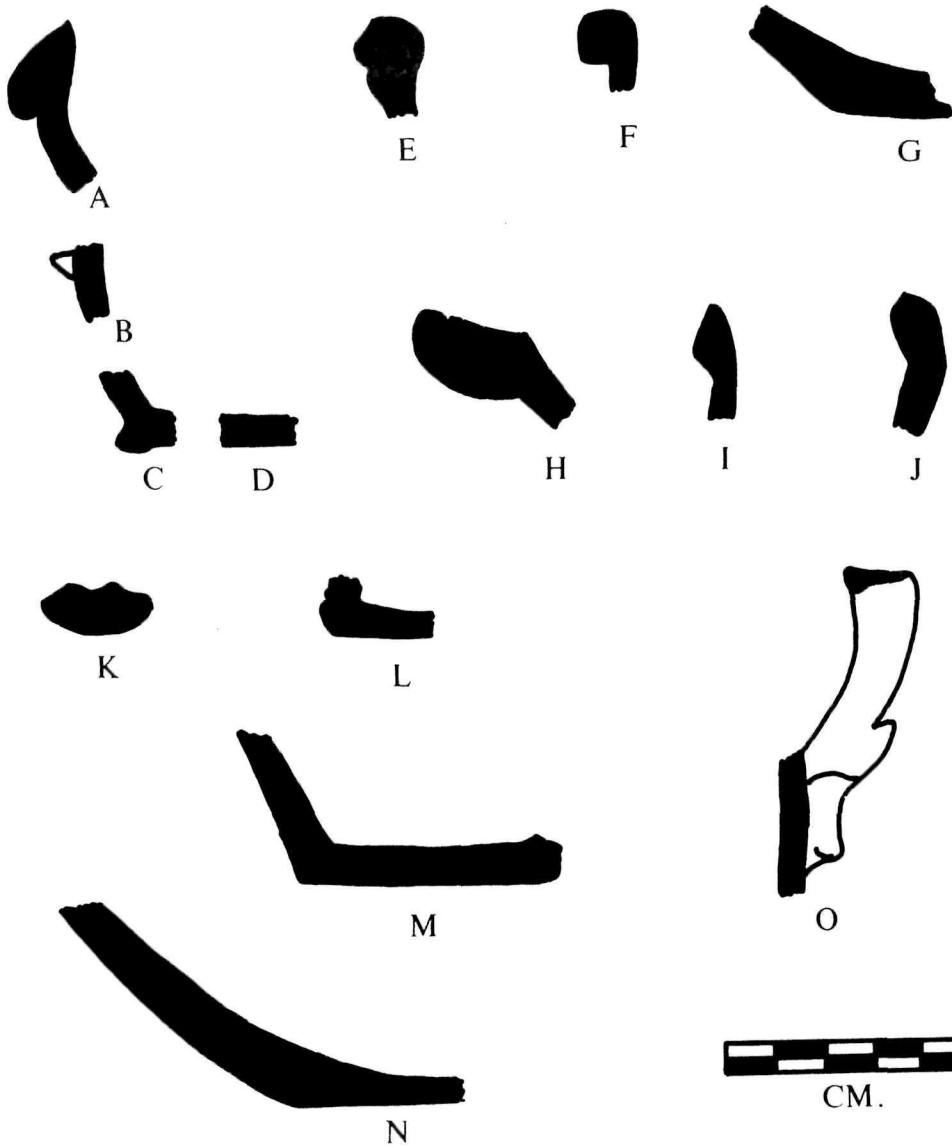
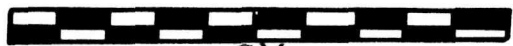
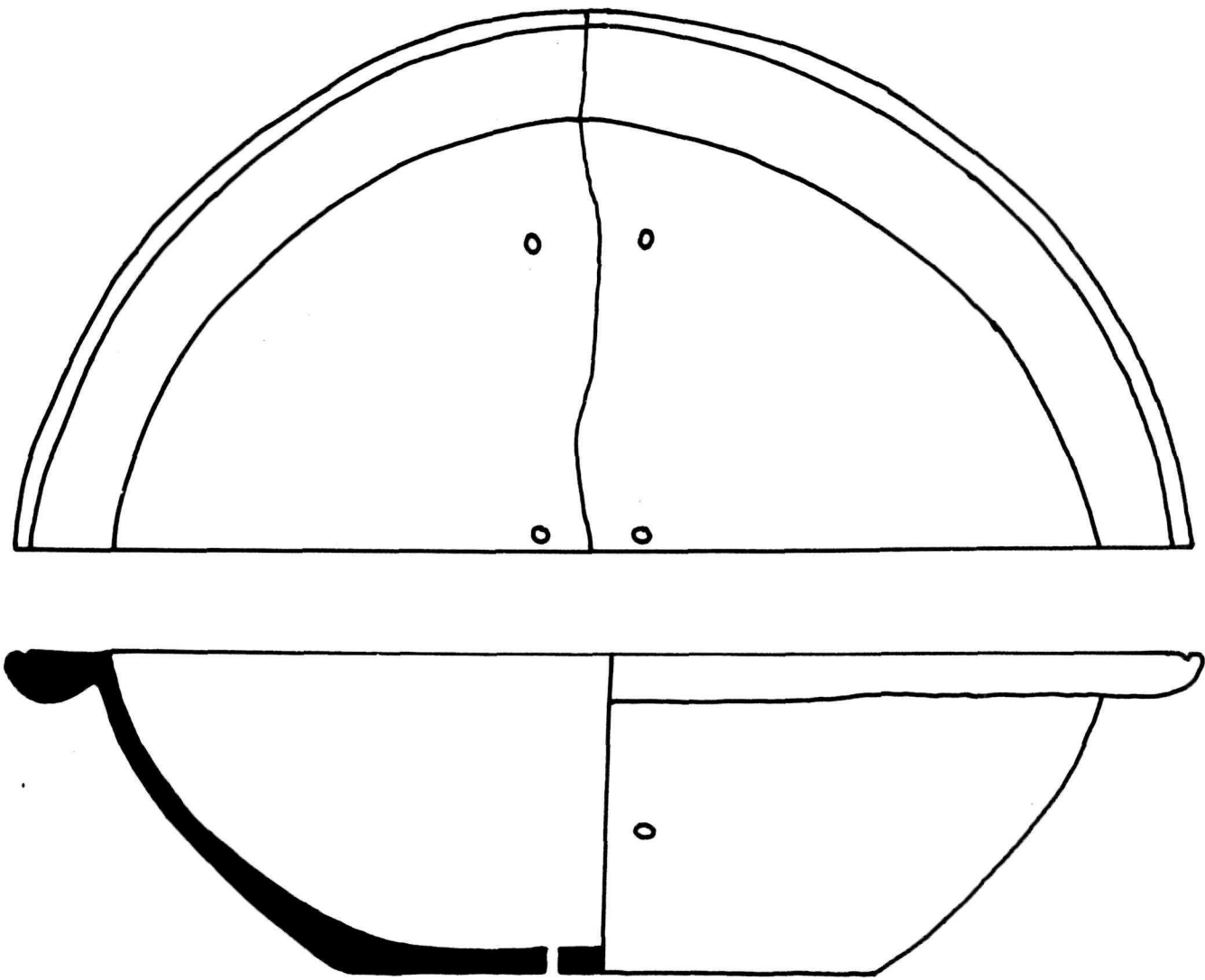

Figure 79. Coarse earthenware, pink paste. Vessel number 70. Note holes for repair of crack. Scale in cm.



CM.

Figure 80. Coarse earthenwares, orange paste, rim shoulder and base profiles. a-f rims, g, shoulder, h-j bases. Vessel numbers: (a) 101, (b) 157, (c) 125, (d) 115, (e) 116, (f) 124, (g) 102, (h) 110, (i) 106, (j) 101. Scale in cm.



A



B



C

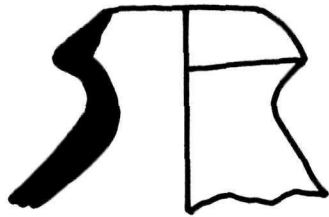

D

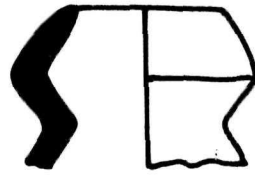

E



F

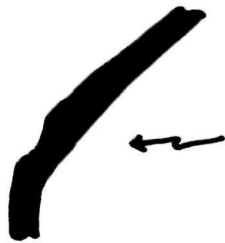

G

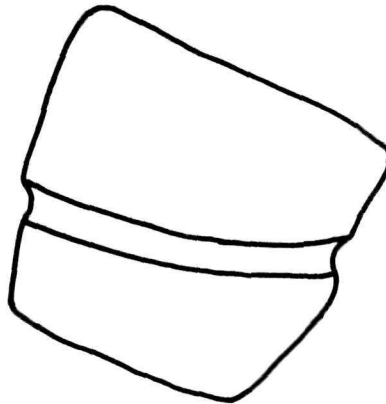

I

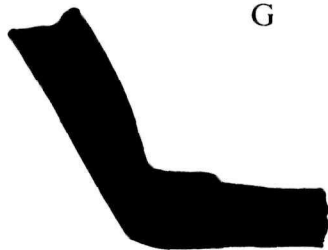

H



J



CM

Figure 81. Coarse earthenwares, orange paste,
vessel rims and bases. Vessel numbers: (a) 134,
(b) 133, rim, (c) 123, base, Scale in cm.

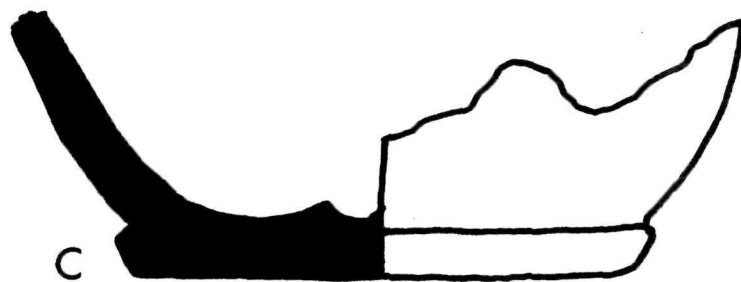
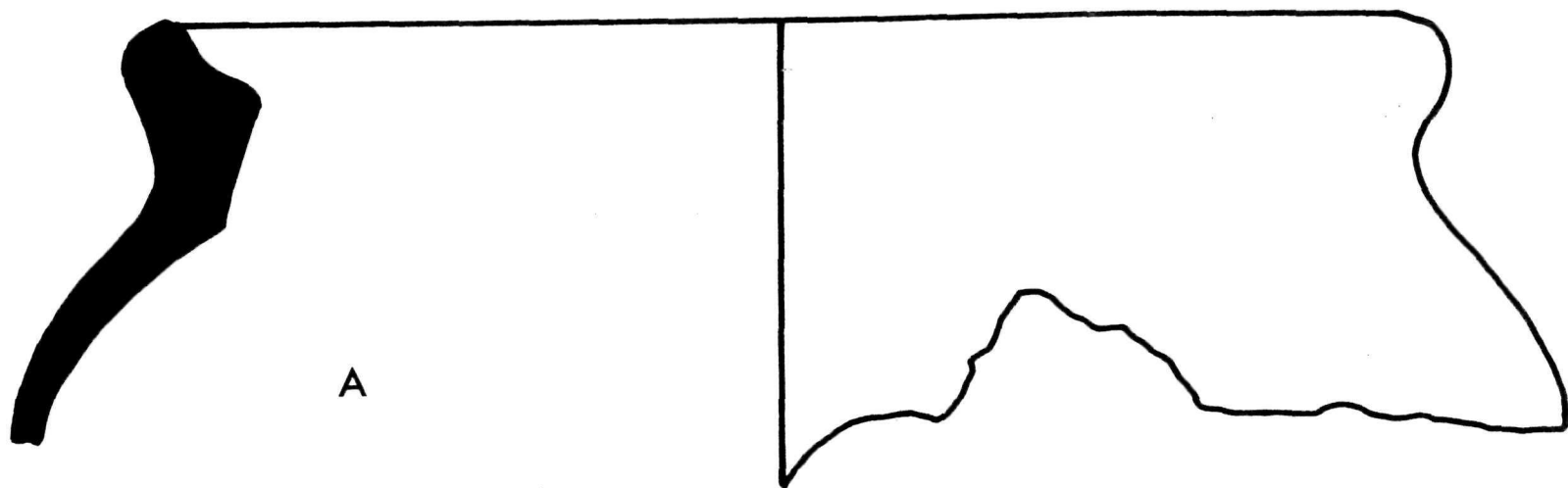
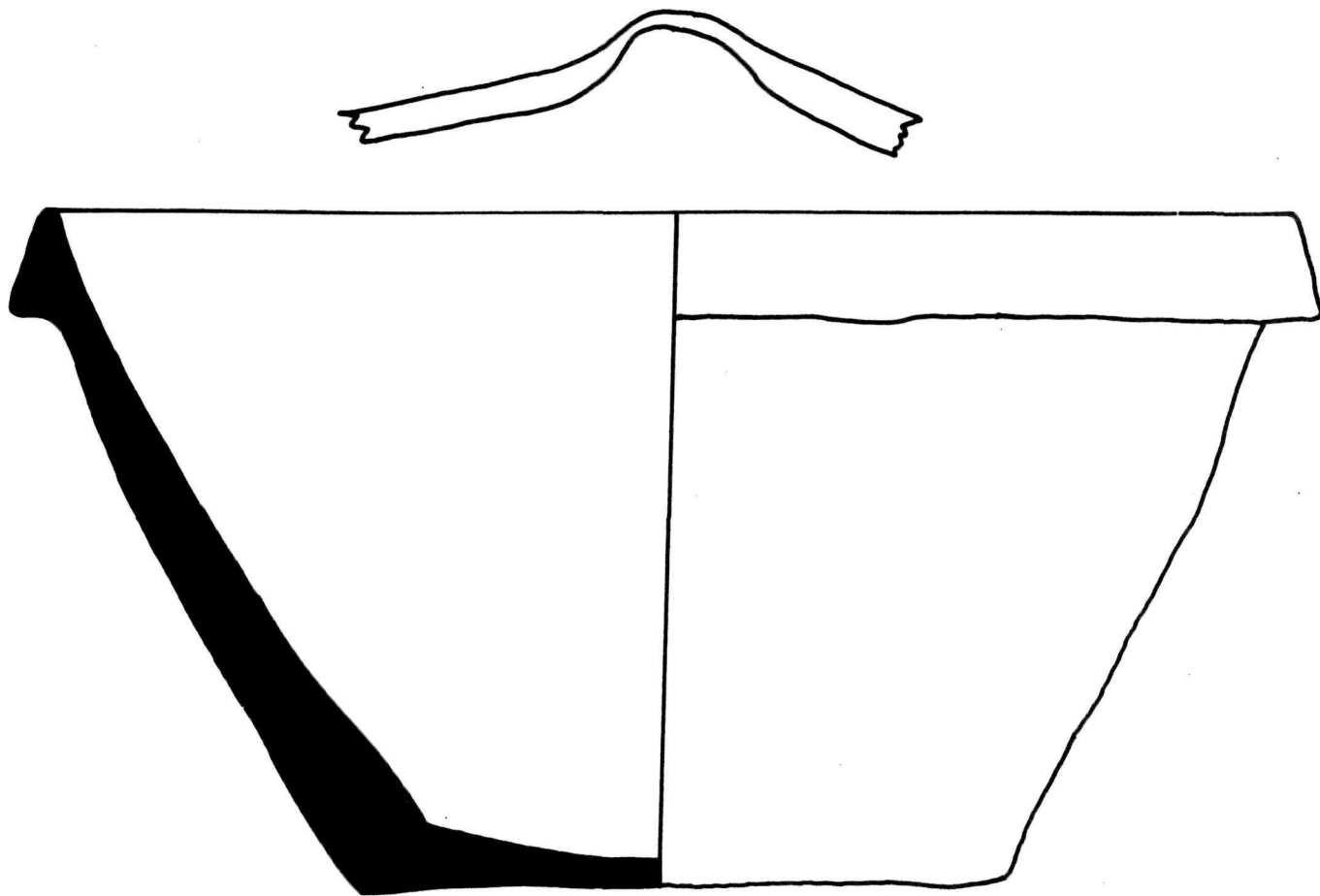
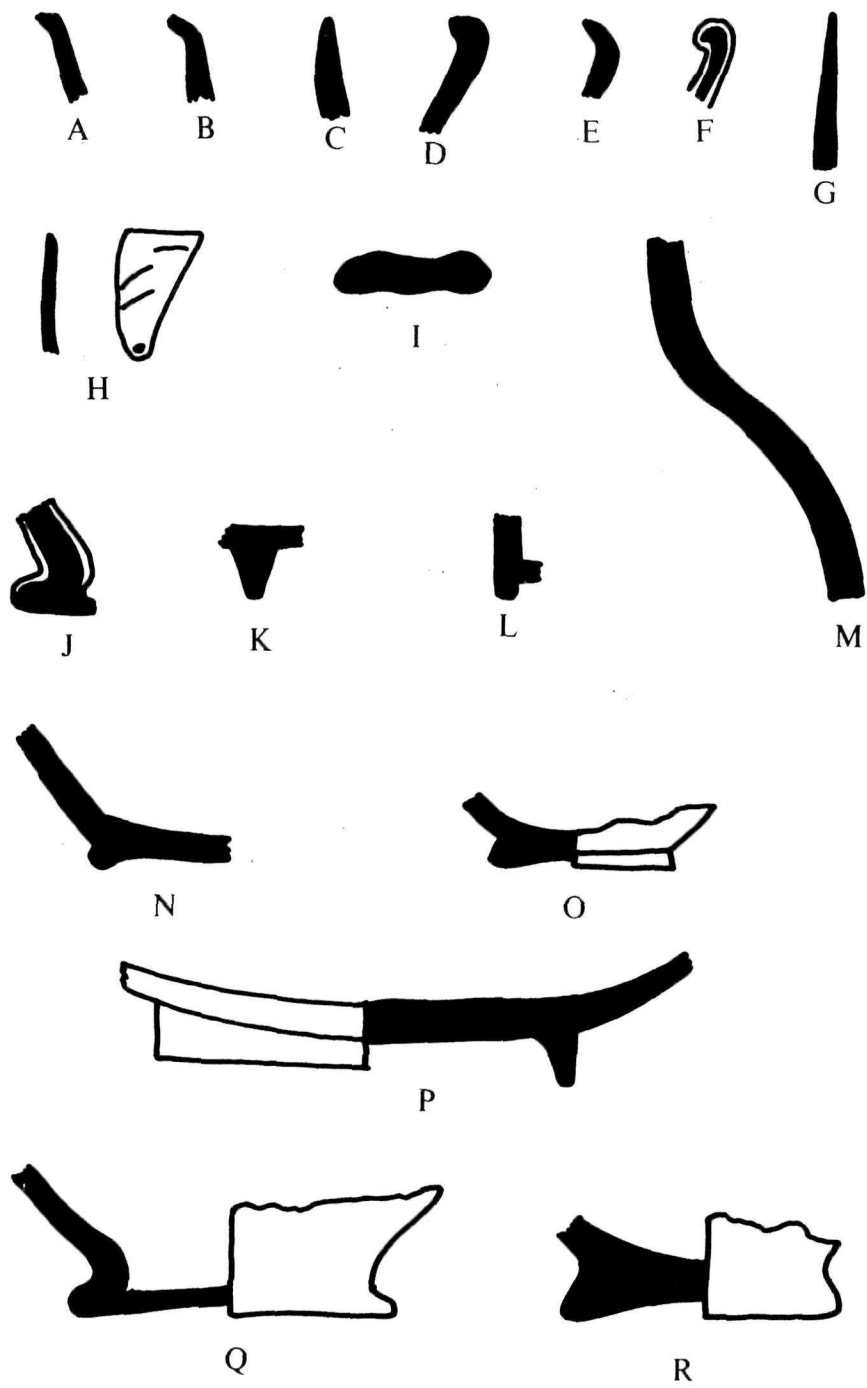

Figure 82. Coarse earthenware, orange paste,
vessel number 132. Scale in cm.



CM.

Figure 83. Tin glazed earthenware. a-h rims;
i, handle cross-section; m, shoulder; n-r bases;
f illustrates exceptionally thick glaze relationship to body. Vessel numbers: (a) 428, (b) 444,
(c) 400, 420, (d) 407, (e) 456, (f) 434, (g) 440,
(h) 435, (i) 418, (j) 403, (k) 427, (l) 455, (m) 406,
(n) 419, (o) 454, (p) 458, (q) 400, (r) 423.
Scale in cm.



CM.

Figure 84. Tin glazed earthenwares, enameled decoration. a. Rouen, b-d floral patterns, e-i Chinese motifs. Vessel numbers: (a) 398, (b) 408, (c) 420 (both inside and outside decorated), (d) 406, (e) 448, (f) 440, (g) 443, (h) 447, (i) 438. Scale in cm.

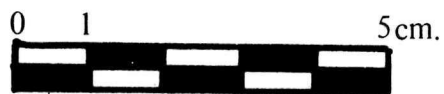
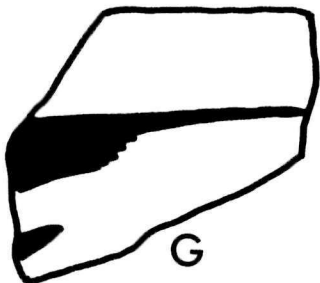
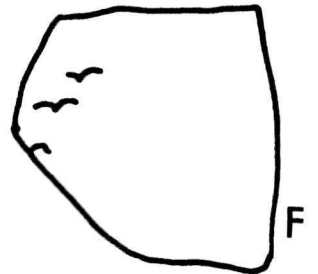
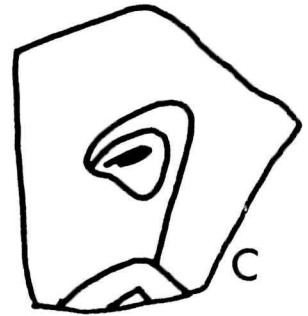
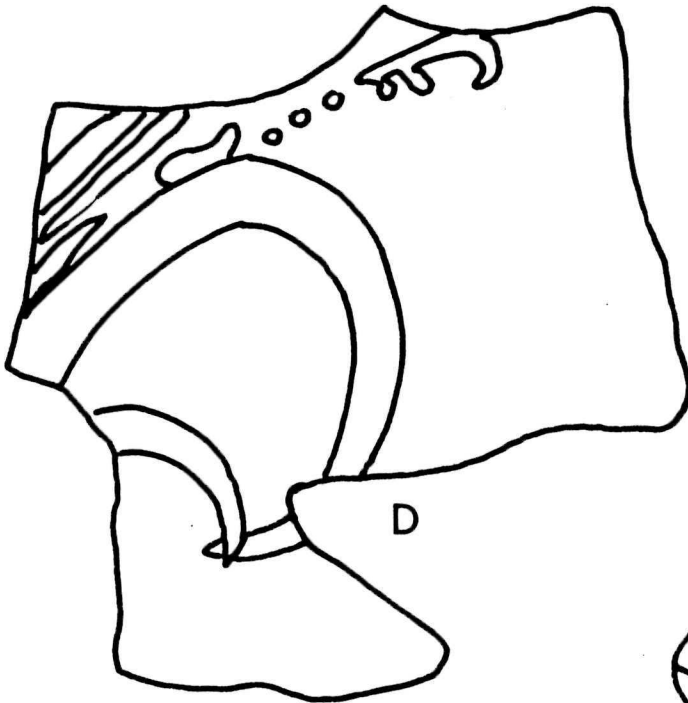
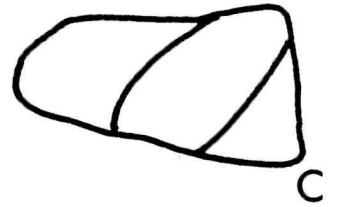
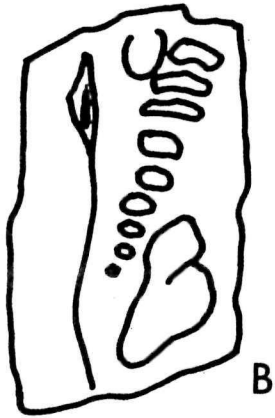
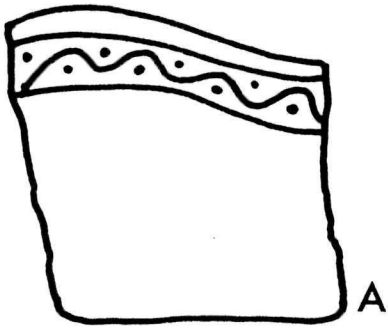

Figure 85. Miscellaneous earthenwares. Vessel numbers: (a) 161, (b) 162, (c) 164, (d) 160 (rim and base), (e) 163, (f) 166, (g) 167, (h) 159. Scale in cm.

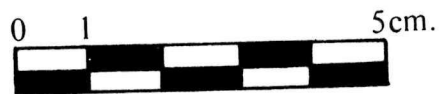
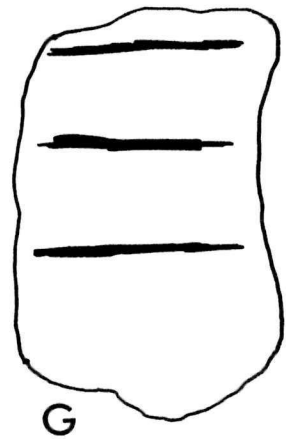
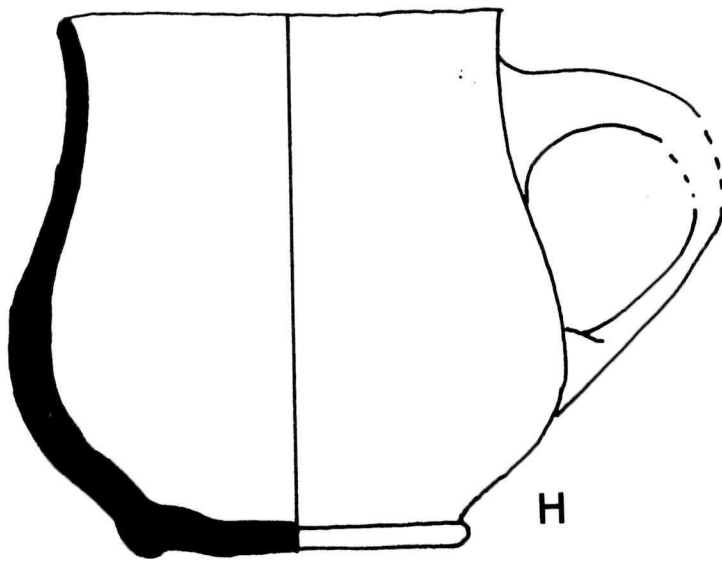
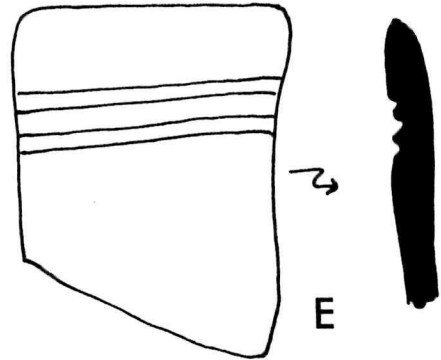
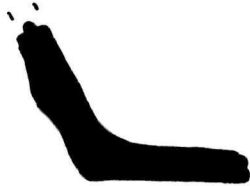
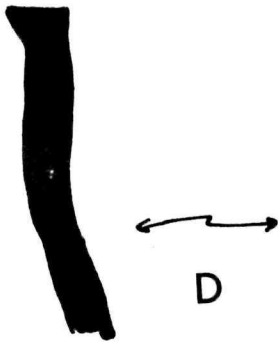
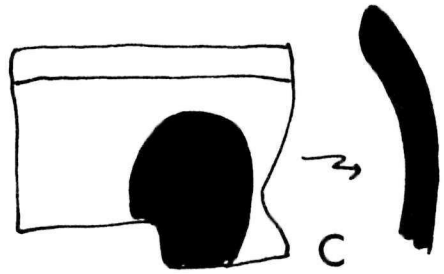

Figure 86. Creamware rim forms and decoration.

Vessel numbers: (a) 391, (b) 392, (c) 393, (d) 388,
(e) 390, (f) 358, (g) 394 (painted), (h) 381,
(i) 376, (j) 387, (k) 382, (l) 383, (m) 383,
(n) 386. Scale in cm.

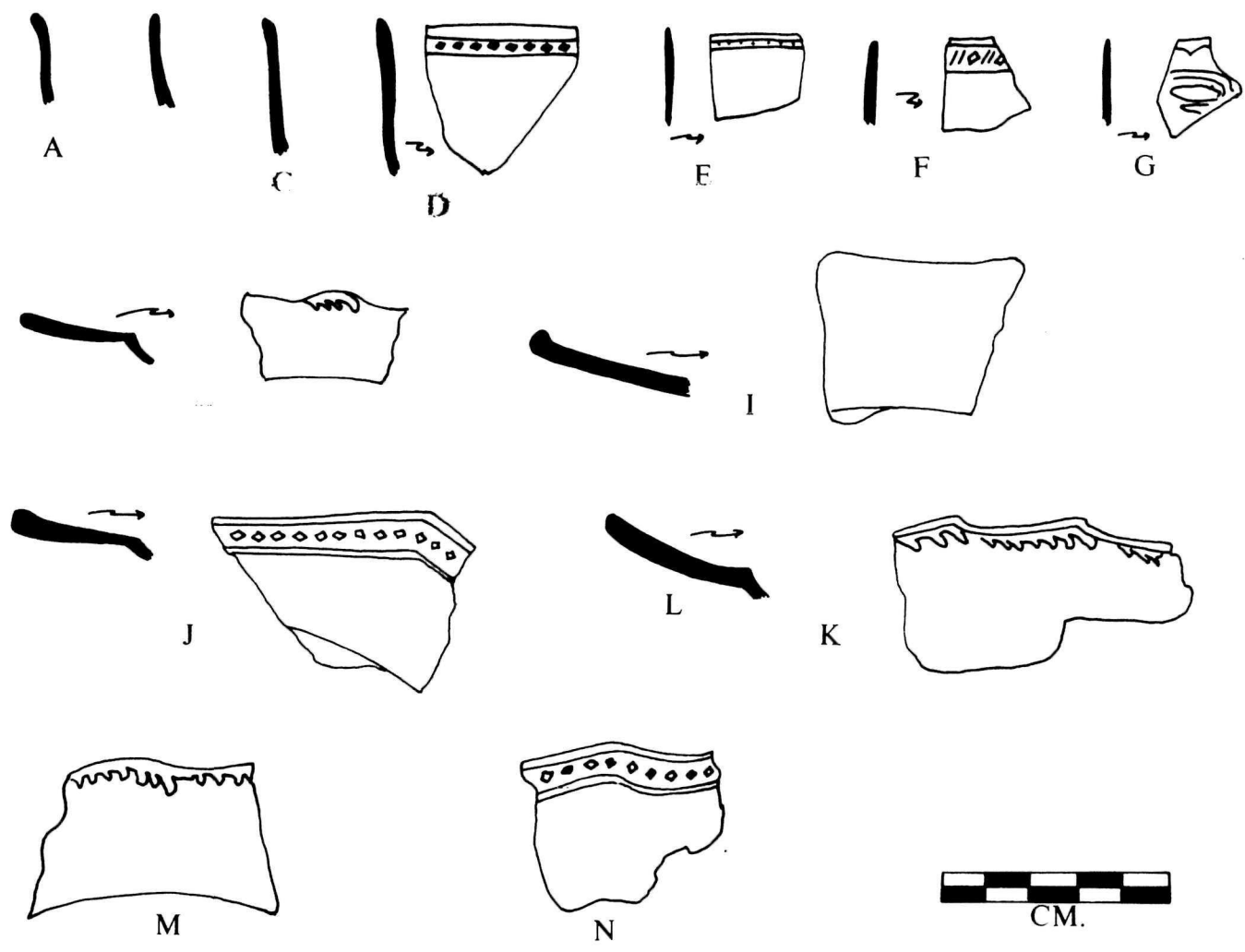

Figure 87. Creamware bases. Vessel numbers:
(a) 367, (b) 370, (c) 372, (d) 366, (e) 364,
(f) 363, (g) 375. Scale in cm.

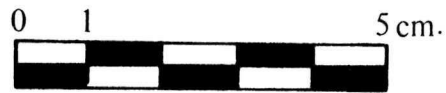
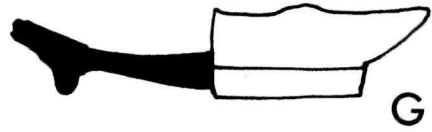
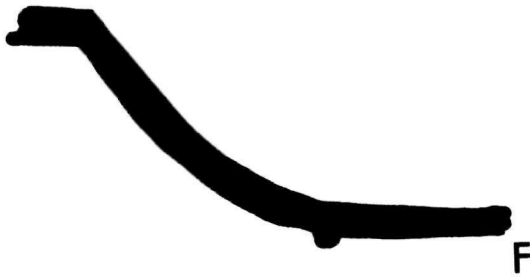
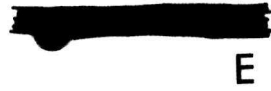
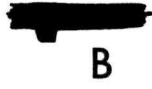
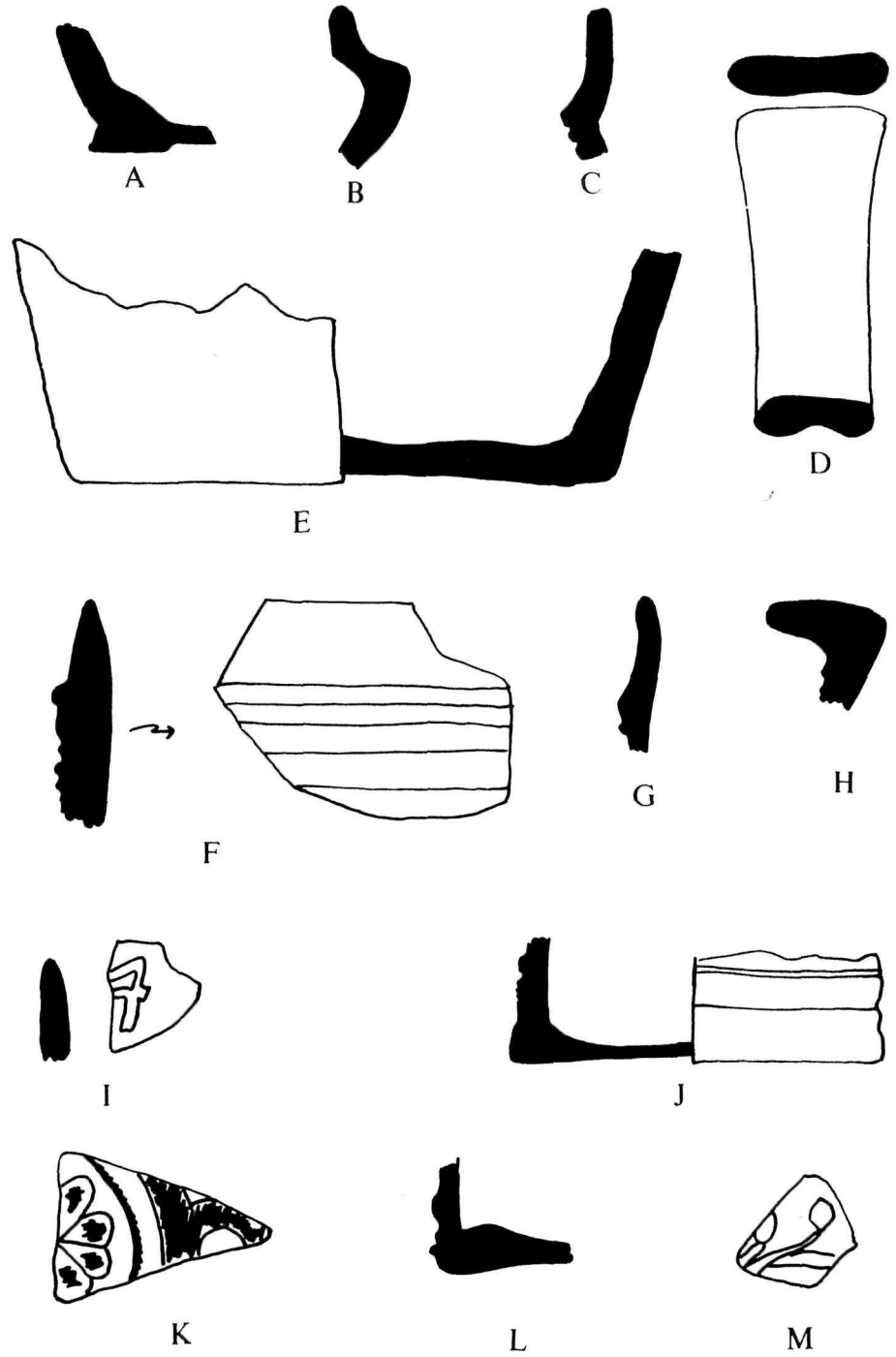

Figure 88. French stoneware and Westerwald salt glazed stoneware; a-e, French stoneware; f-m, Westerwald salt glazed stoneware. Vessel numbers: (a) 189, (b) 194, (c) 190, (d) 192 (handle), (e) 192 (base), (f) 204, (g) 197, (h) 199, (i) 205, (j) 198, (k) 207, (l) 212, (m) 202. Scale in cm.



CM.

Figure 89. Brown salt glazed stoneware, restorable
vessel number 180. Scale in cm.

1941

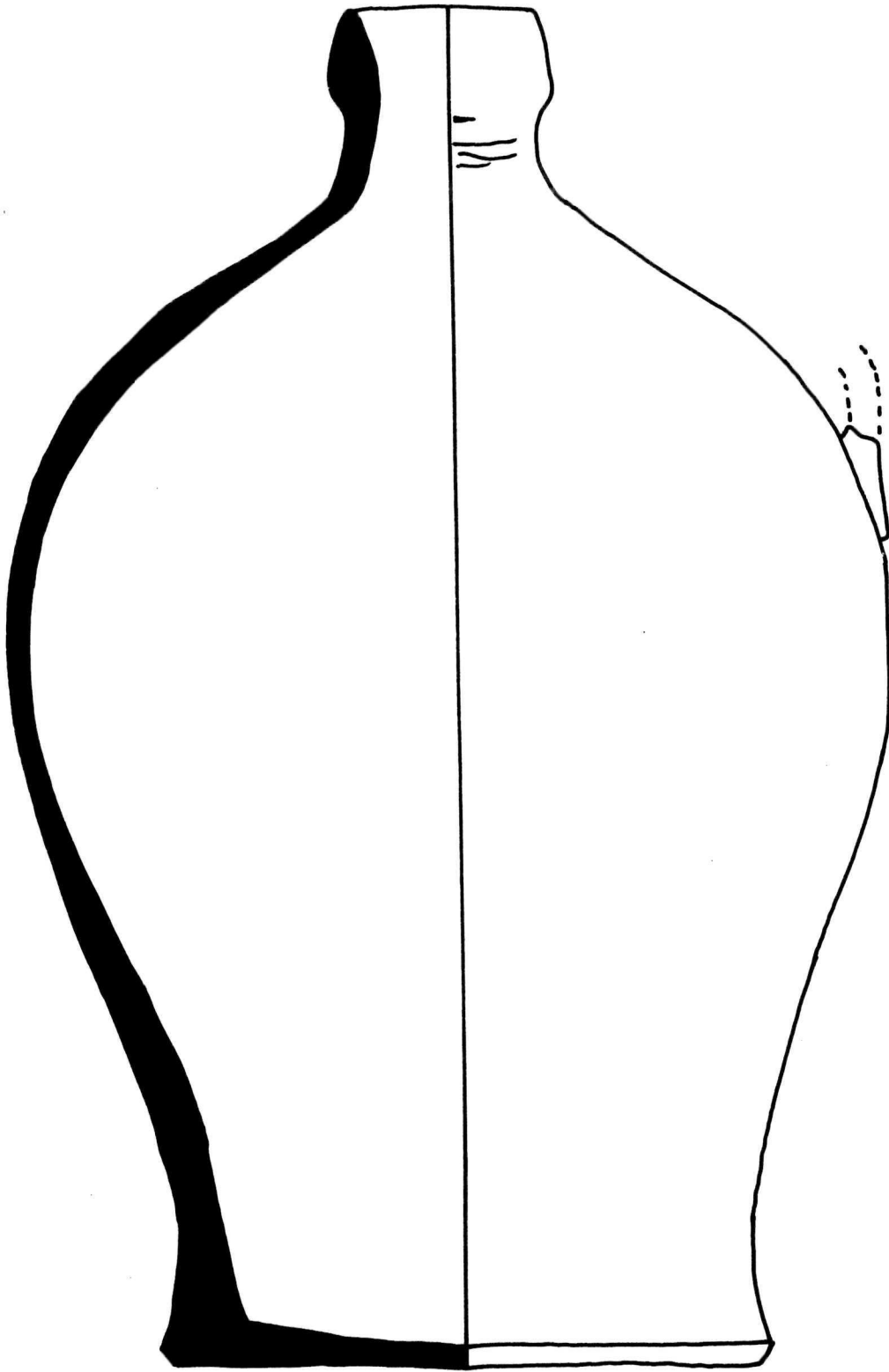

CM.

Figure 90. Brown salt glazed stoneware bases.
(a) vessel 170, (b) vessel 168. Scale in cm.

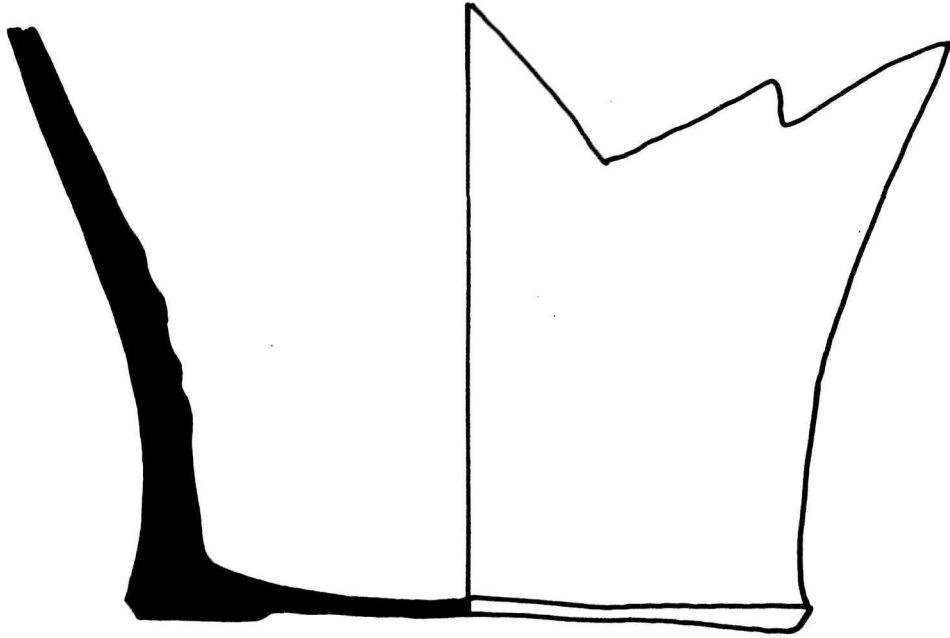

A

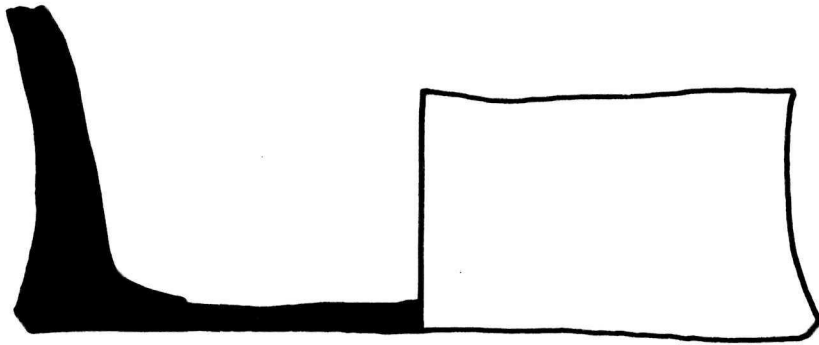

B



CM.

Figure 91. White salt glazed stoneware, wheel turned. a-h rim forms, j handle, i, k-z, a' base and foot ring forms. Vessel numbers: (a) 284, (b) 270, (c) 289, (d) 268, (e) 275, (f) 267, (g) 303, (h) 329, (i) 216, (j) 328, (k) 240, (l) 215, (m) 224, (n) 242, (o) 218, (p) 225, (q) 235, (r) 243, (s) 219, (t) 226, (u) 236, (v) 220, (w) 238, (x) 242, (y) 221, (z) 227, (a') 250. Scale in cm.

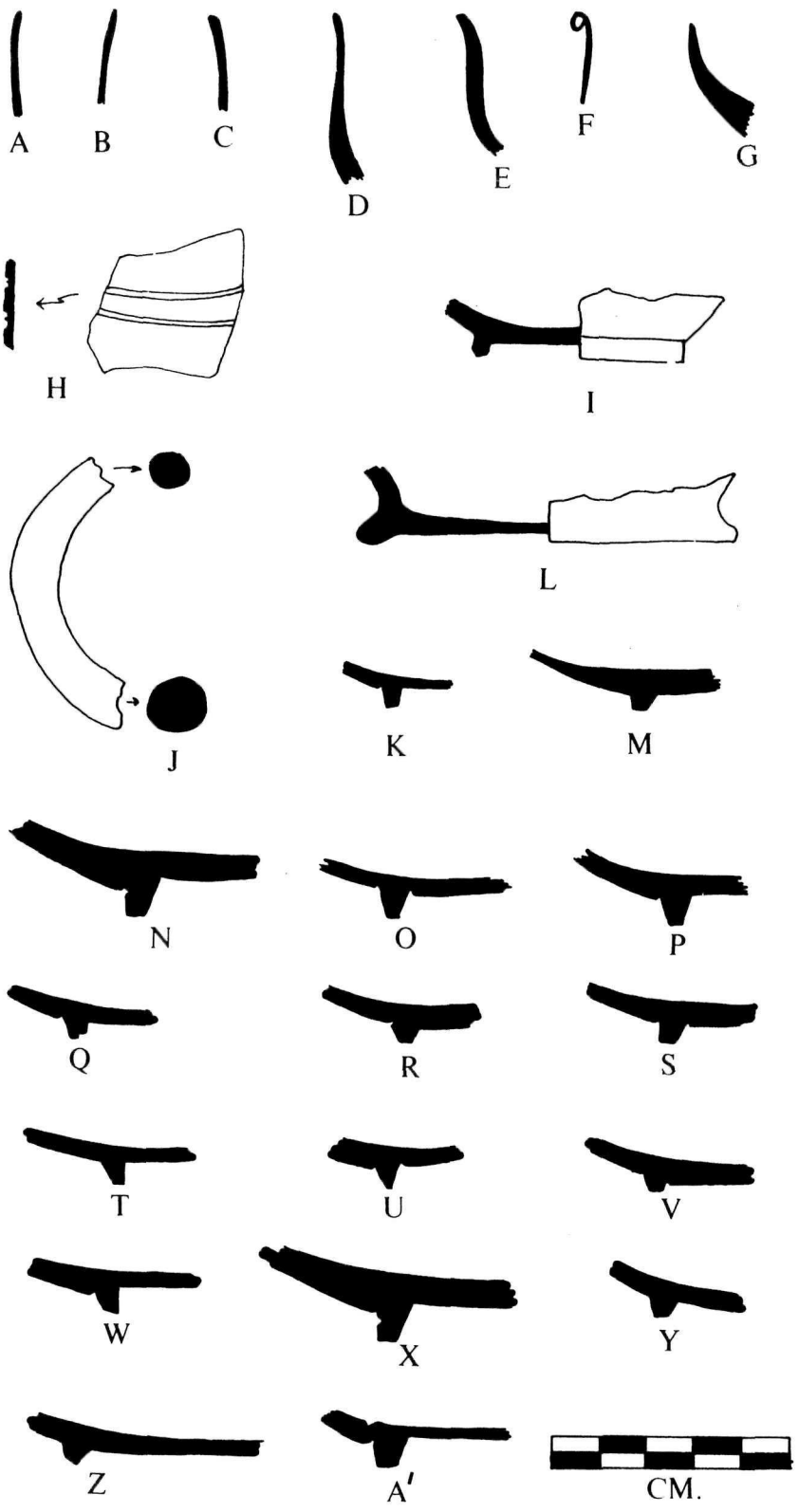

Figure 92. White salt glazed stoneware, pressed.
a, b bases, c-f rims. Vessel numbers: (a) 339,
(b) 341, (c) 349, (d) 349, (e) 342, (f) 343. Scale
in cm.

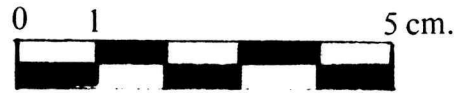
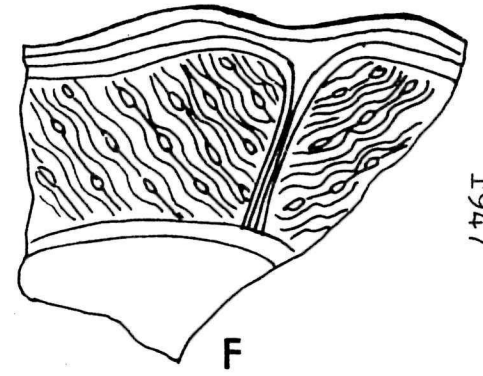
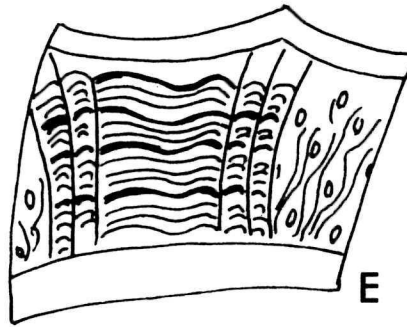
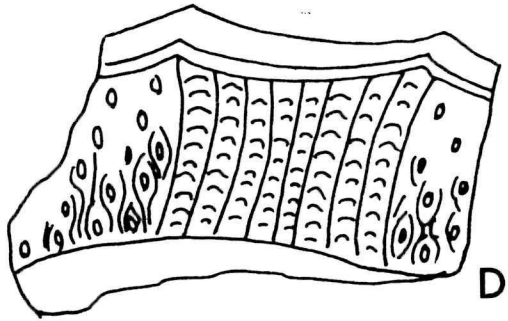

Figure 93. Miscellaneous stonewares. a mug, b finial,
c lid, d handle, e base. Vessel numbers: (a) 351,
(b) 354, (c) 355, (d) 352, (e) 353. Scale in cm.

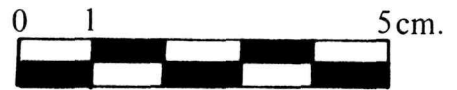
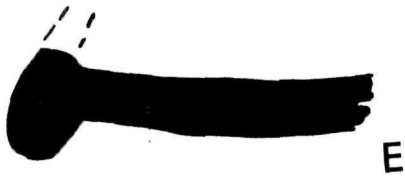
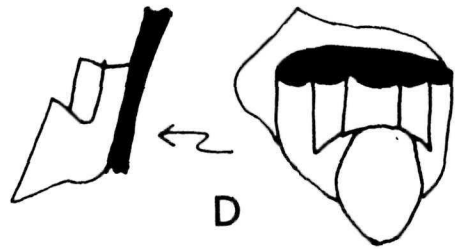
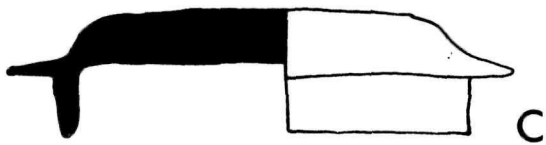
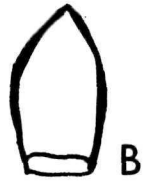
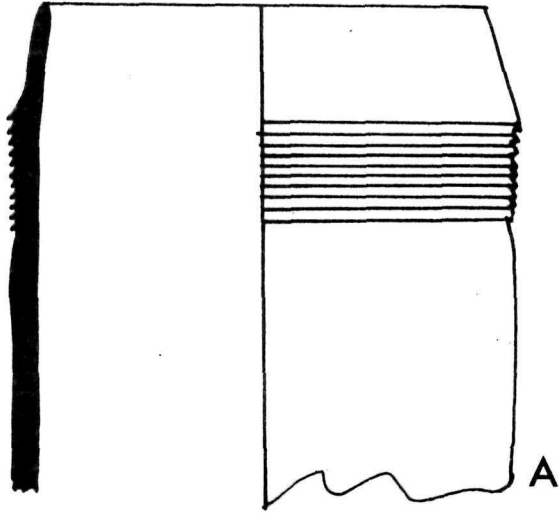

Figure 94. Porcelain. a-g Chinese, h-j English.

Vessel numbers: (a) 471, (b) 474, (c) 472, (d) 473,
(e, f) 476, (g) 478, (h) 480, (i) 481, (j) 479.

Scale in cm.

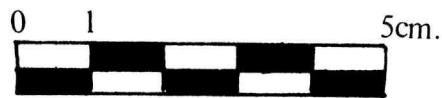
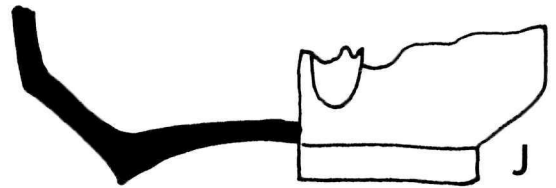
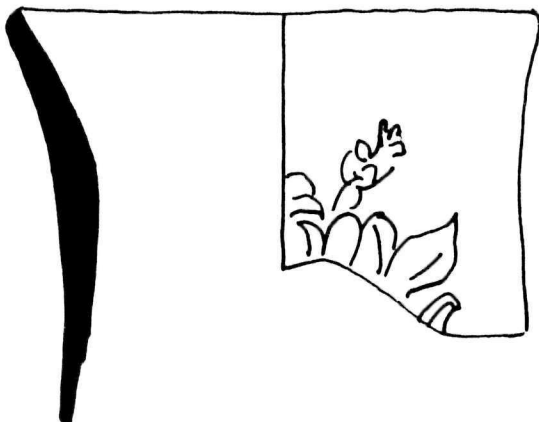
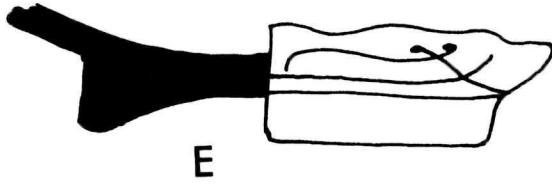
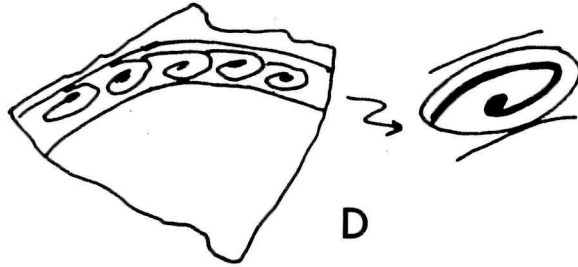
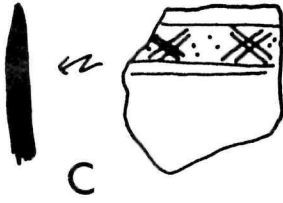
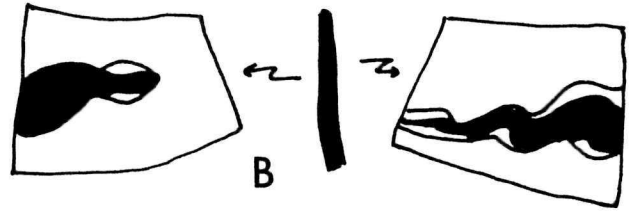
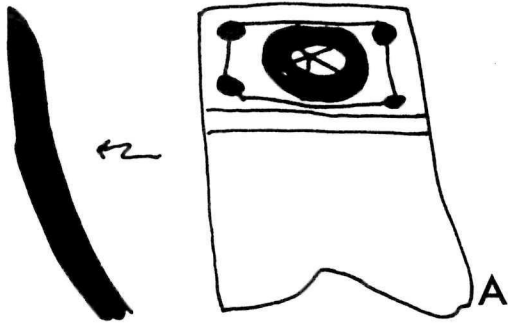

Figure 95. Pipe bowl types. Type numbers: (a) 1,
(b) 2, (c) 3, (d) 4, (e) 5, (f) 6, (g) 7, (h) 8,
(i) 9, (j) 10, (k) 11, (l) 12. Scale in cm.
(a) complete specimen.

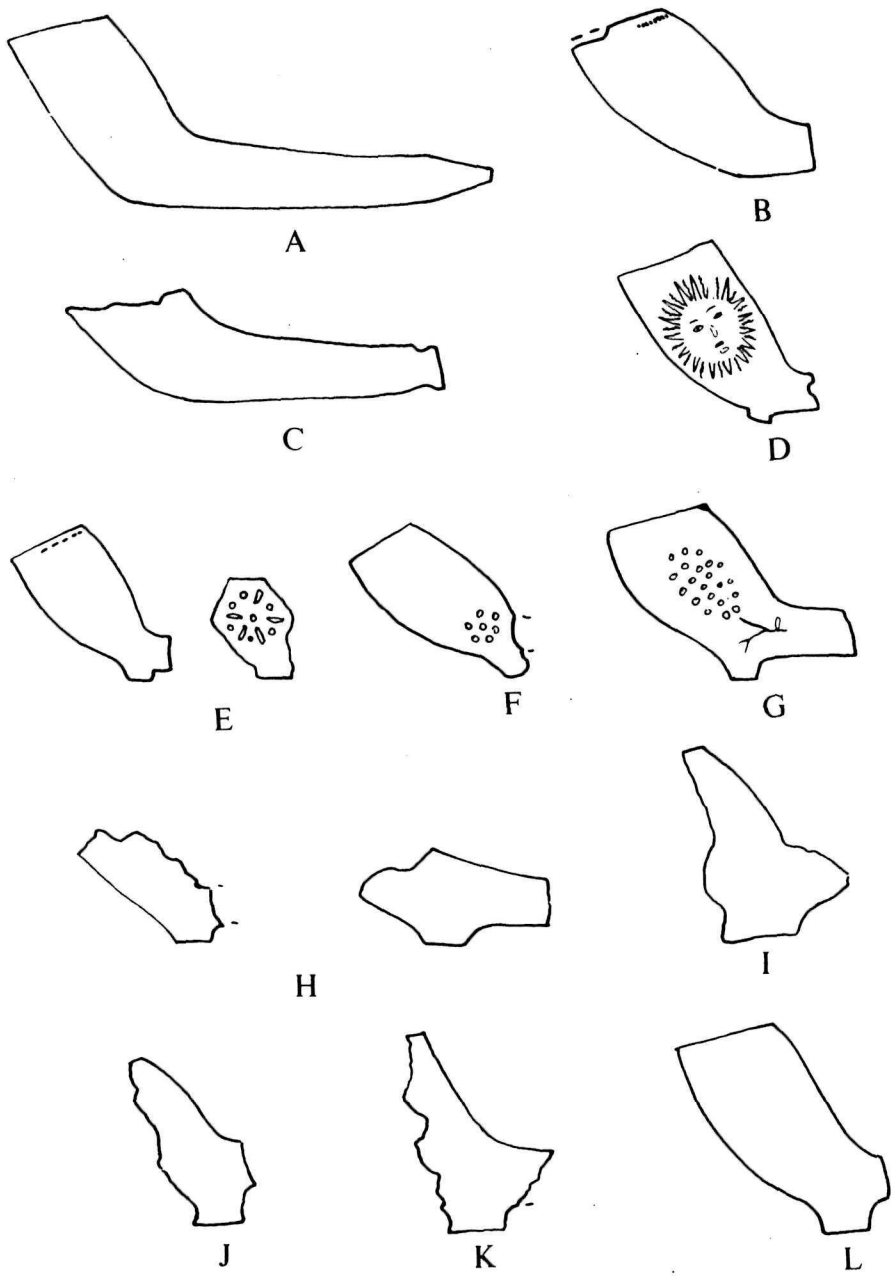
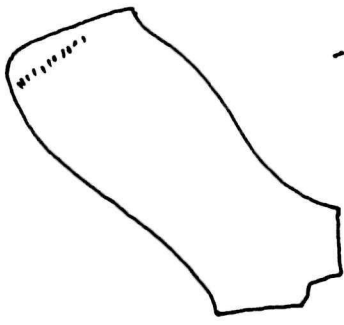

Figure 96. Pipe bowl types. Type numbers:

(a) 13, (b) 14, (c) 15, (d) 16, (e) 17, (f) 18,

(g) 19, (h) 20, (i) 21, (j) 22. Scale in cm.



A



B

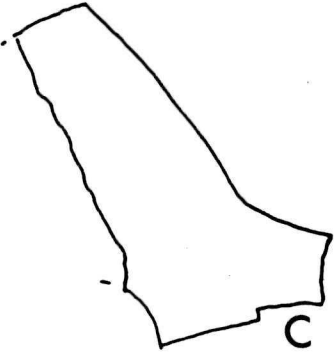

C

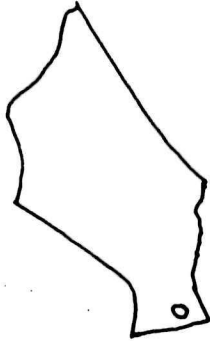

D



E

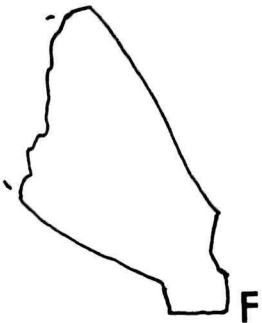
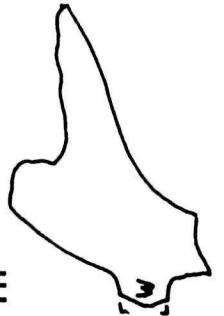

G



H

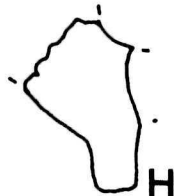

I

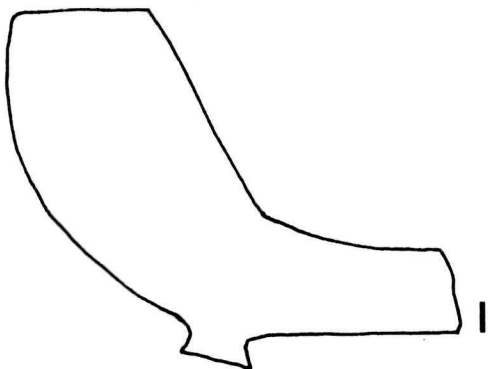

J

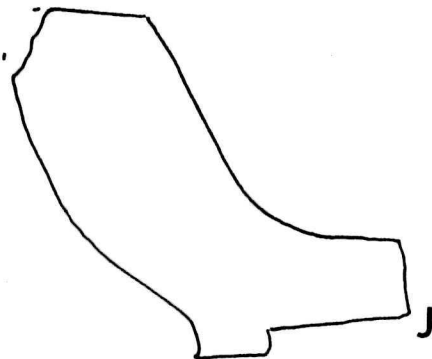

K

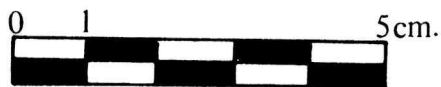

Figure 97. Pipe bowl types. Type numbers: (a) 23,
(b) 24, (c) 25, (d) 26, (e) 27, (f) 28, (g) 29,
(h) 30, (i) 31, (j) 32, (k) 33, (l) 34, (m) 35,
(n) 36.

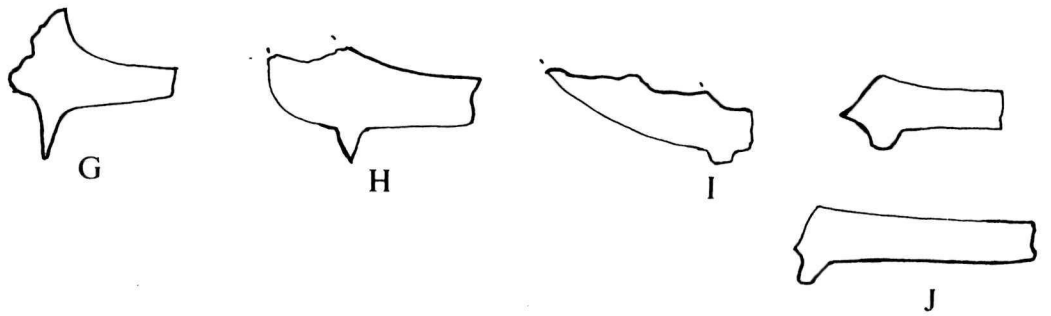
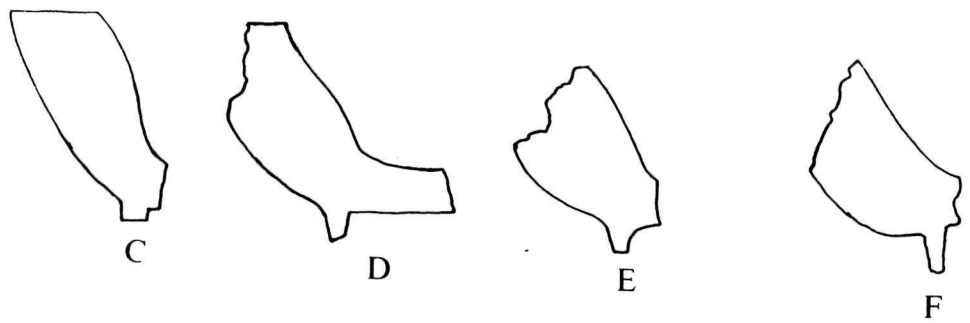
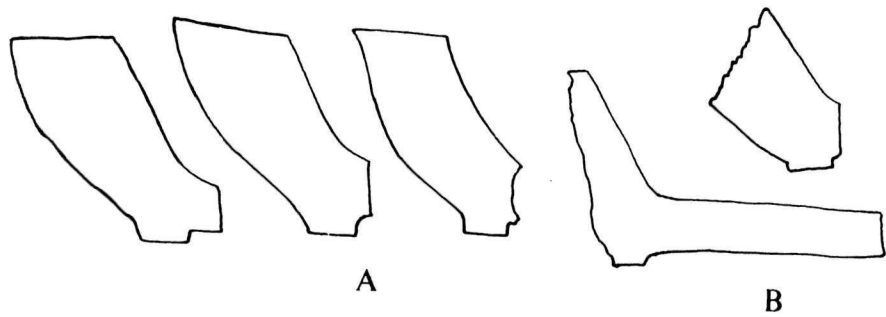

Figure 98. Pipe stem mouthpiece types and stem decoration. a-f mouthpiece types, g-q enlarged stem design elements. Mouthpiece type numbers: (a) M1, (b) M2, (c) M3, (d) M4, (e) M5, (f) M6. Scale in cm. Design elements: (g) a, (h) b, (i) c, (j) d, (k) e, (l) f. Decorated stem types: (m) 1A, (n) 1B, (o) 1C, (p) 2, (q) 3. Designs not to scale.

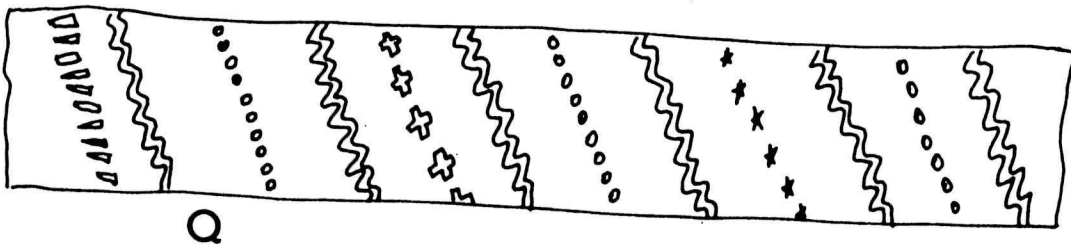
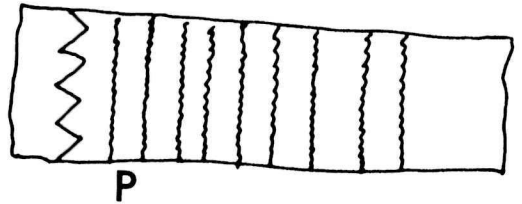
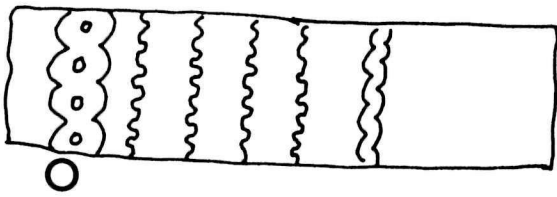
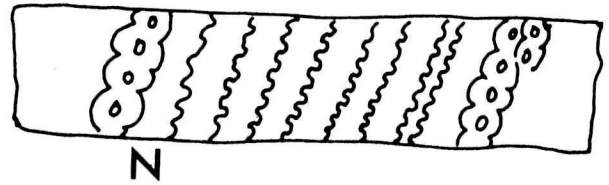
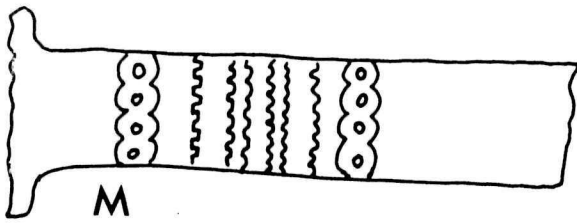
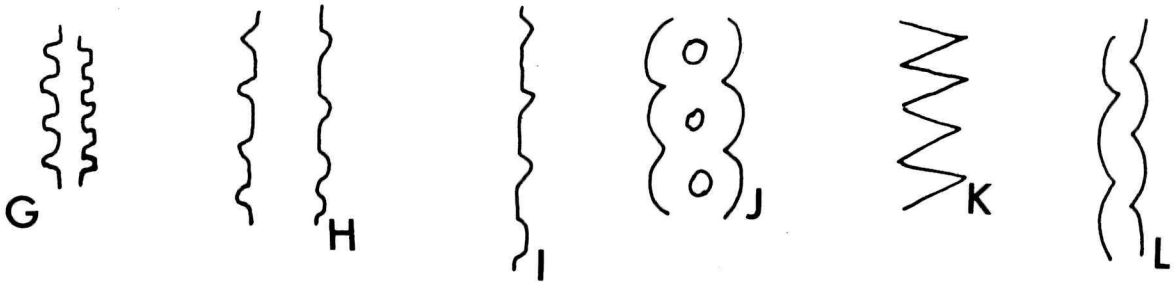
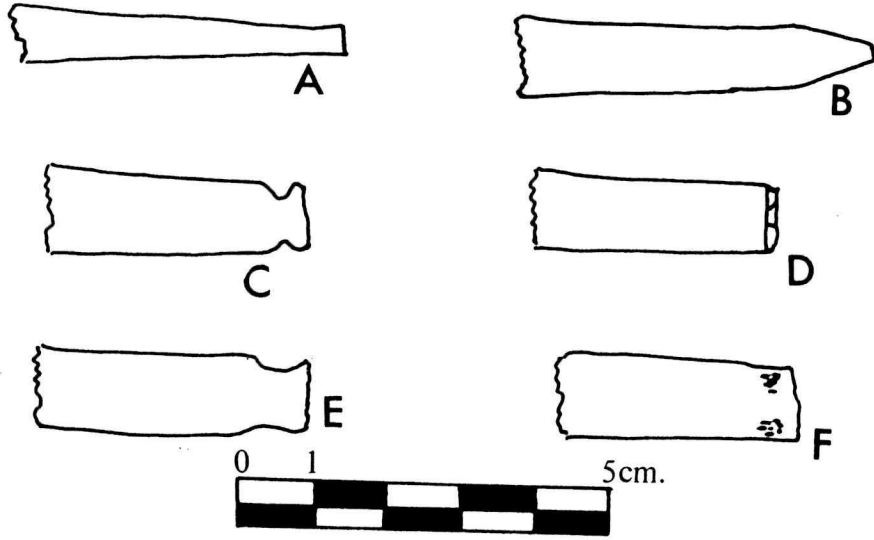
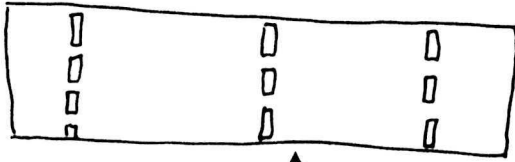

Figure 99. Pipe stem design types. Decorated stem types: (a) 4, (b) 5, (c) 6, (d) 7, (e) 8, (f) 9, (g) 10, (h) 11, (i) 12, (j) 13. Not to scale.



A



B

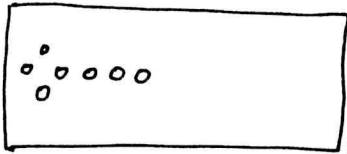

C

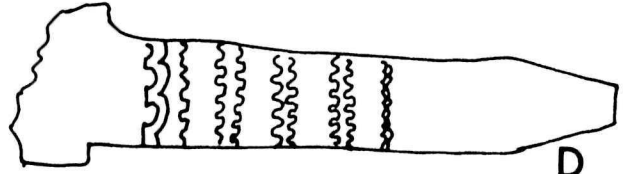

D

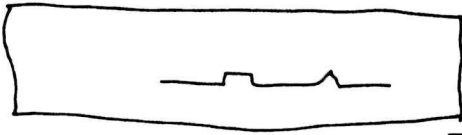

E

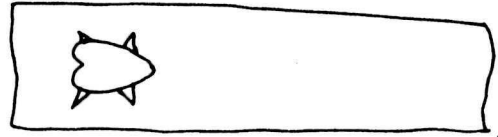

F

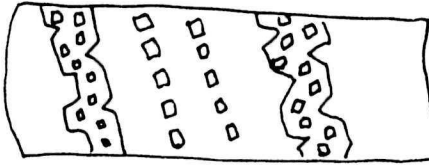

G

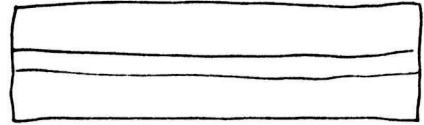

H

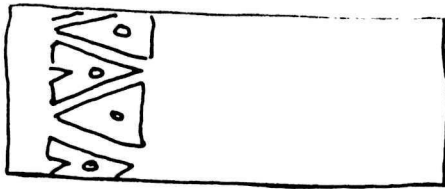

I

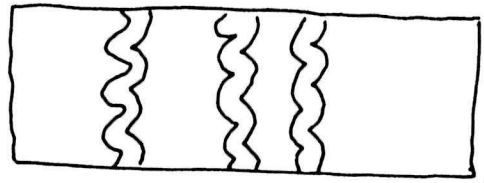

J

Figure 100. Makers' names and initials. Name type numbers: (a) 1, (b) 2, (c) 3, (d) 4, (e) 6, (f) 7, (g) 8, (h) 9, (i) 9, (j) 10, (k) 11, (l) 13, (m) 12, (n) 14, (o) 15, (p) 16. Not to scale.

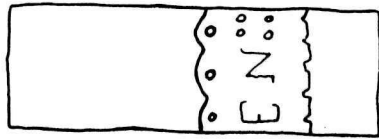

A



B

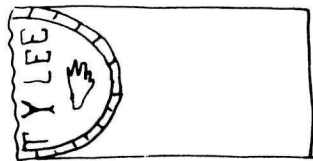

C

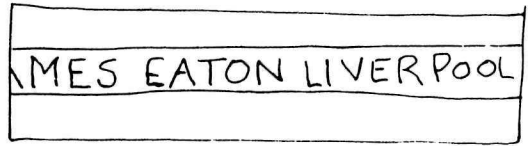

D



E



F

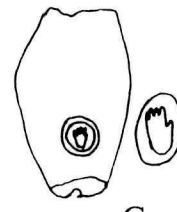

G

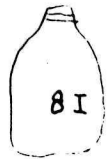

H



I



J



K



L



M



N



O

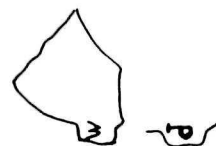

P

Figure 101. Makers' marks on heels. Name types:
(a) 17, (b) 18, (c) 19, (d) 20, (e) 21, (f) 22. Not
to scale.

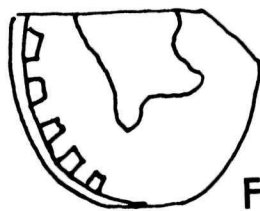
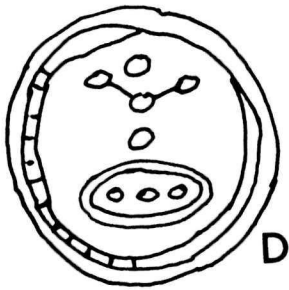
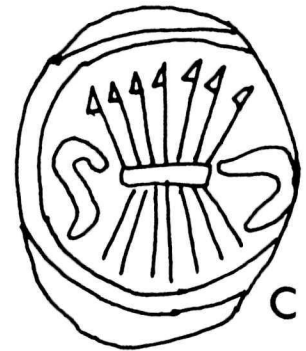

Figure 102. Glass bottle fragments, rims and bases.

Type numbers: (a) 1, (b) 2, (c) 3, (d) 3, (e) 4,
(f) 4, (g) 4, (h) 5, (i) 7, (j) 9, (k) 10. Scale
in cm.

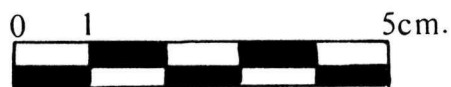
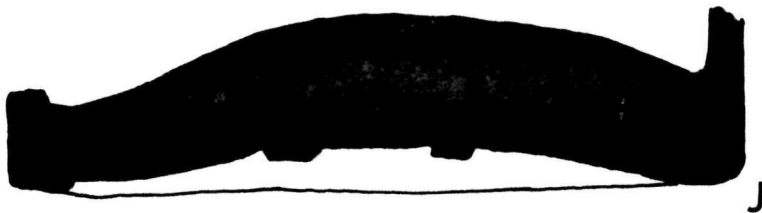
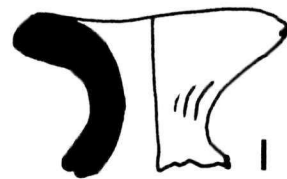
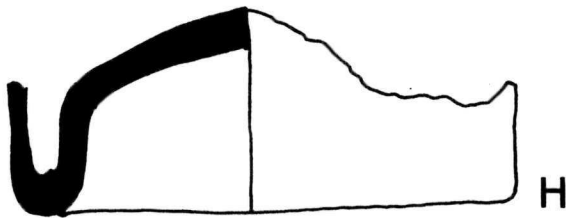
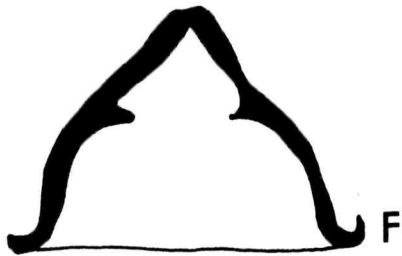
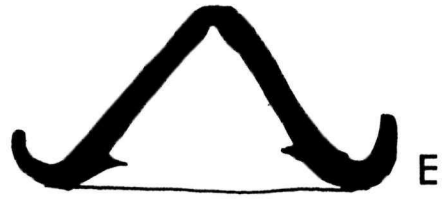
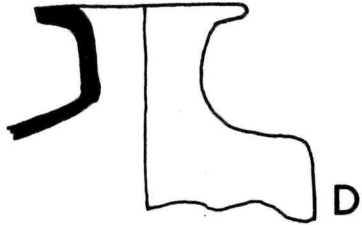
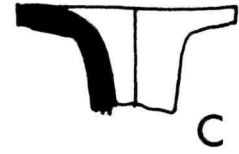
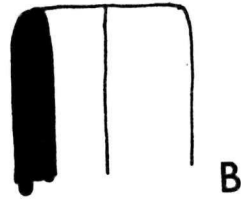
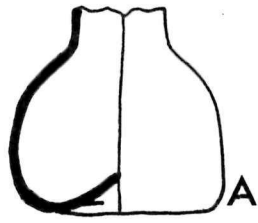
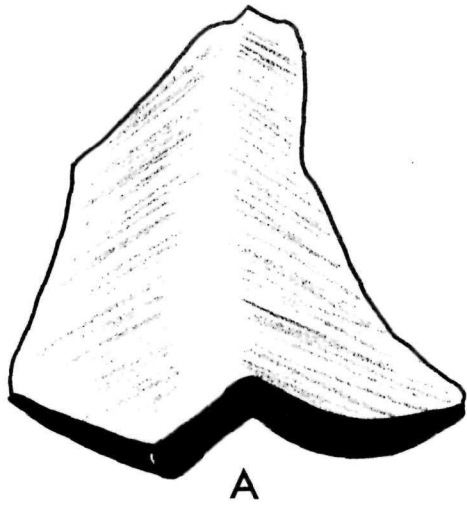

Figure 103. Glass bottle fragments. Type numbers:

(a) 13, (b) 13, (c) 14, (d) 15, (e) 16, (f) 17.

Scale in cm.



A

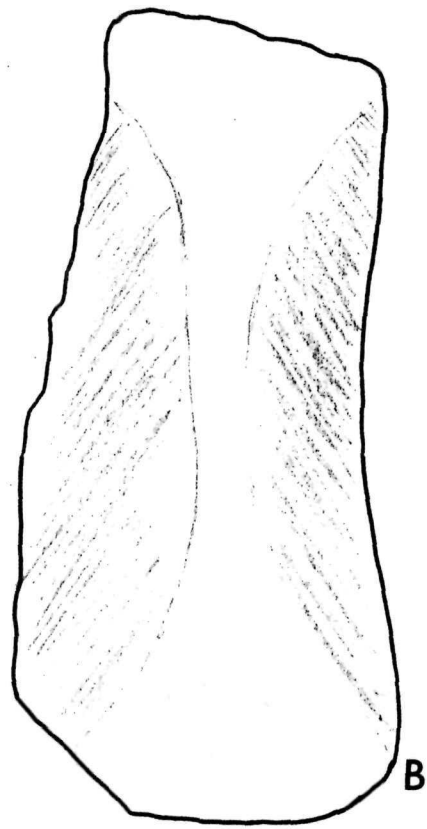

B



C

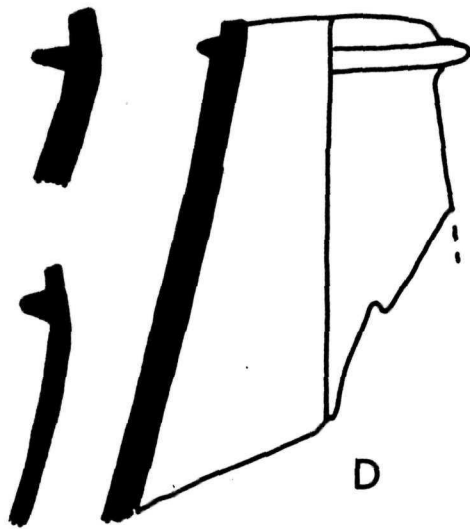

D

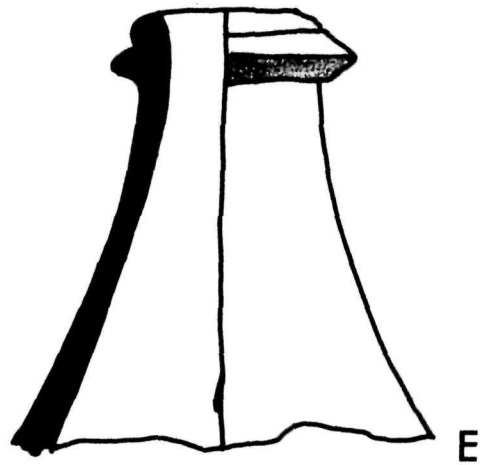

E

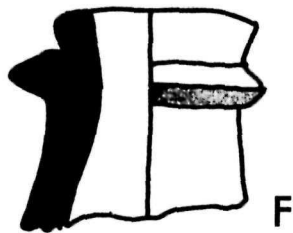

F

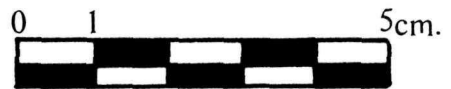
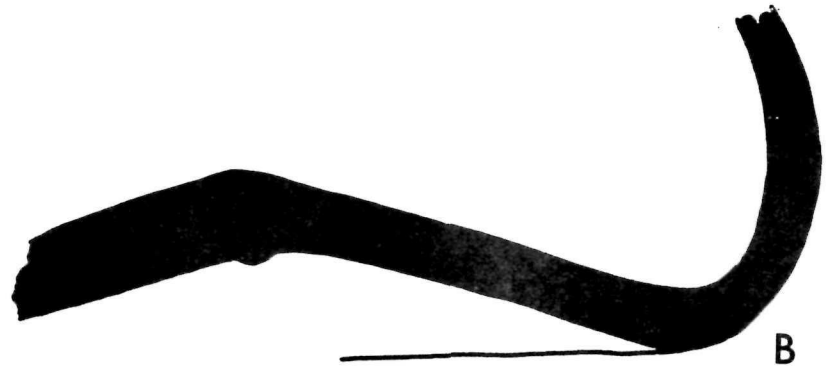

Figure 104. Glass bottle fragments. Type numbers:
(a) 18, (b) 18, (c) 19, (d) 20. Scale in cm.



A



B

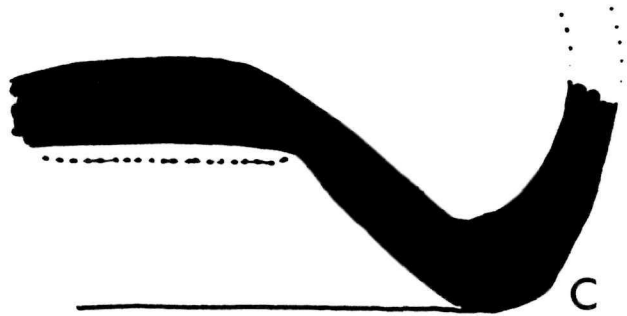

C

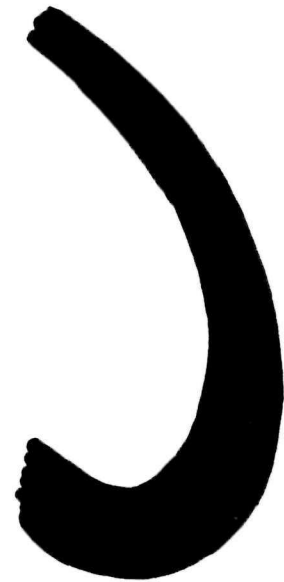

D

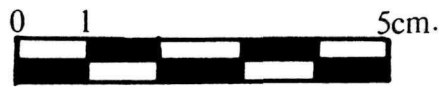
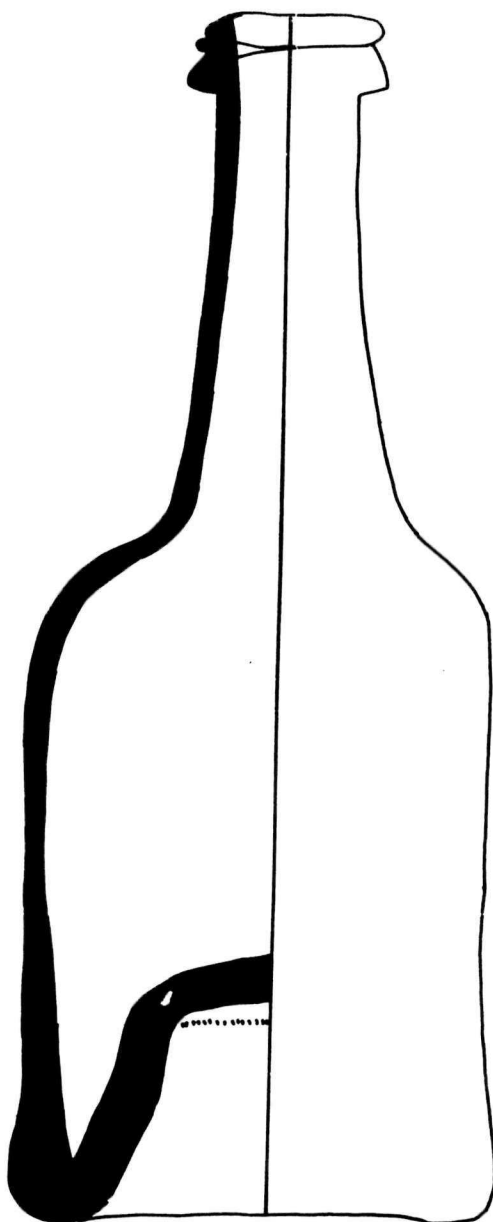

Figure 105. Restorable bottle and bottle seals.

Type numbers: (a) 22, (b, c) 47. Scale in cm.



A



B



C

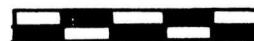

CM.

Figure 106. Glass bottle fragments. Type numbers:

(a) 21, (b) 23, (c) 23, (d) 24, (e) 25, (f) 26.

Scale in cm.

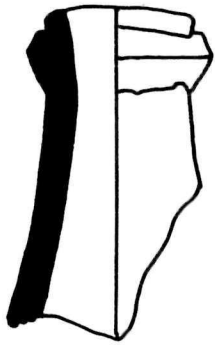

A

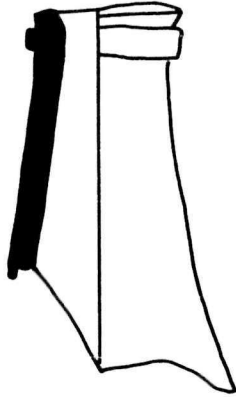

B

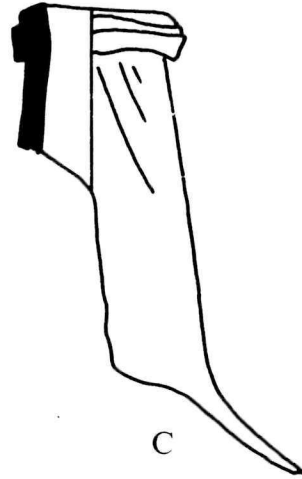

C

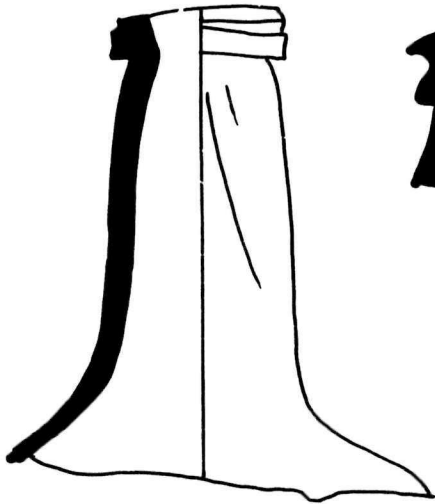

D



E



F



CM.

Figure 107. Glass bottle fragments. Type numbers:
(a) 27, (b) 28, (c) 29, (d) 30, (e) 31 (high), (f)
31 (low). Scale in cm.

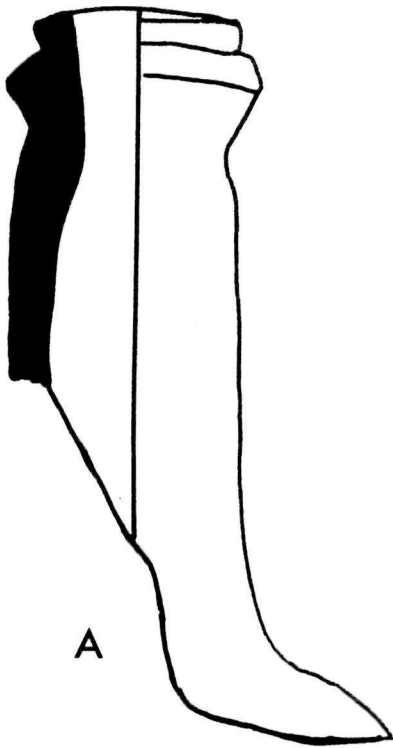

A

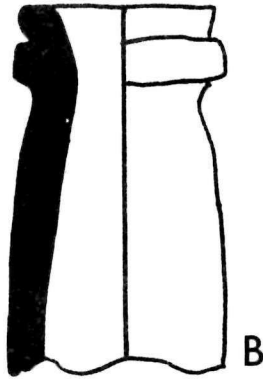

B

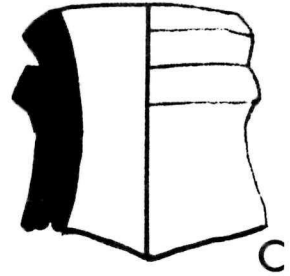

C

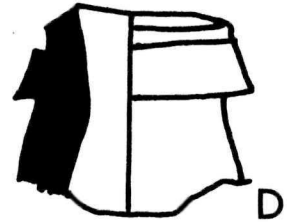

D

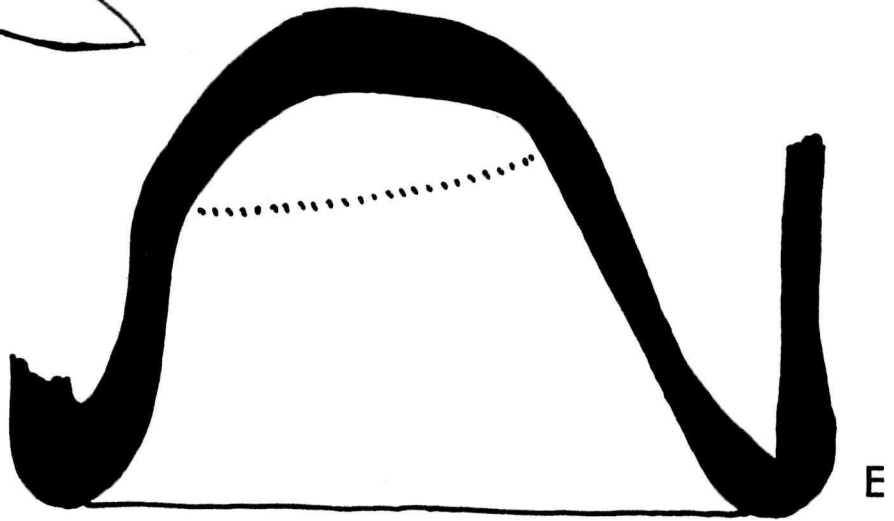

E



F

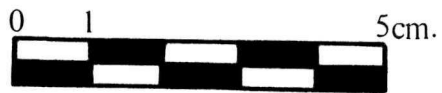
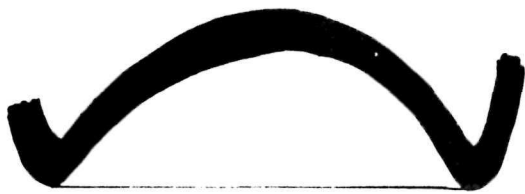

Figure 108. Glass bottle fragments. Type numbers:

(a) 32, (b) 33, (c) 34, (d) 34, (e) 35, (f) 35,

(g) 34. Scale in cm.



A

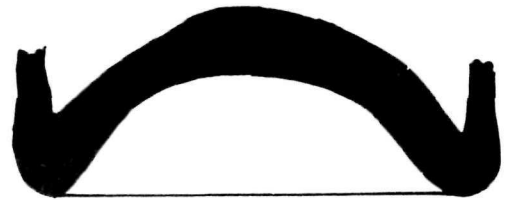

B

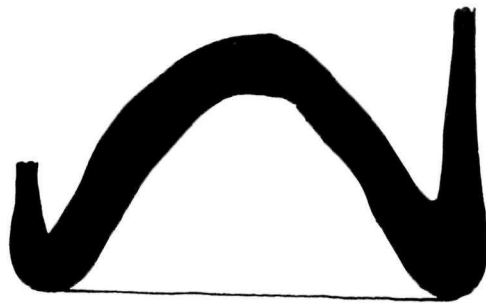

C

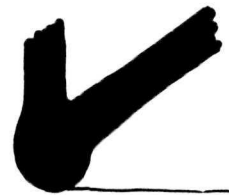

D

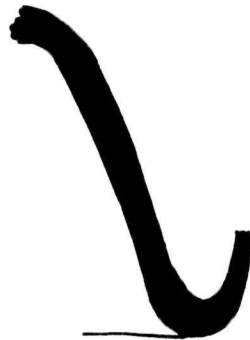

E



F

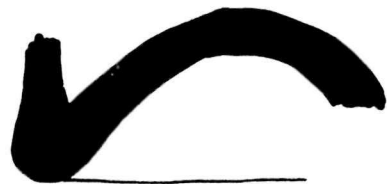

G

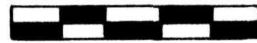

CM.

Figure 109. Glass bottle fragments. Type numbers:

(a) 41, (b) 42, (c) 43, (d) 44, (e) 45, (f) 46.

Scale in cm.

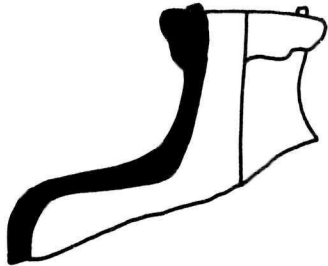

A

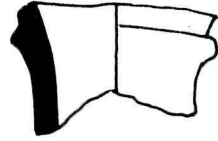

B

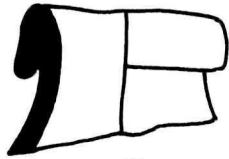

C

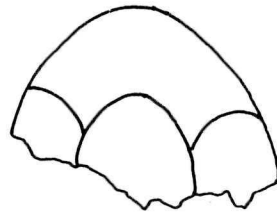

E



D

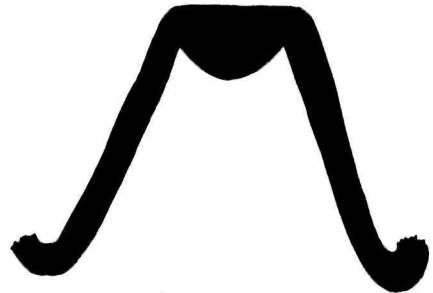

F



CM.

Figure 110. Glass artifacts. (a-h) stemware fragments, (i) bead, (j) inlaid plate glass, (k) faceted glass. Scale in cm.

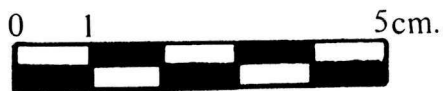
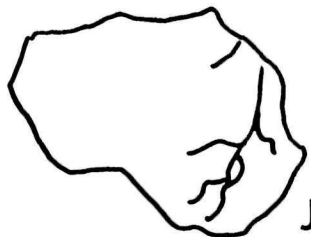
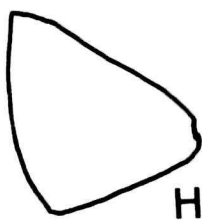
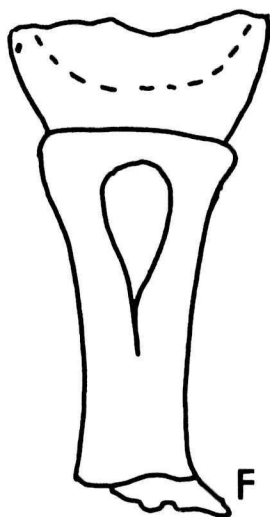
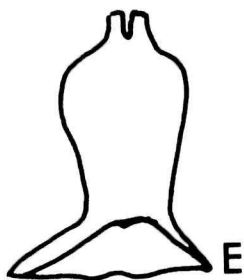
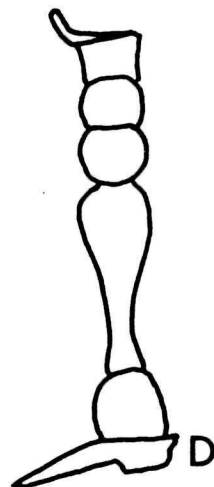
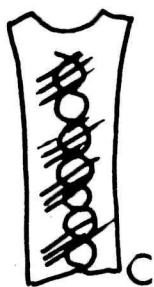
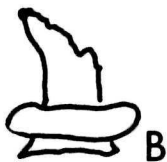
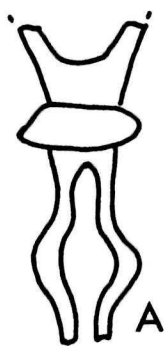
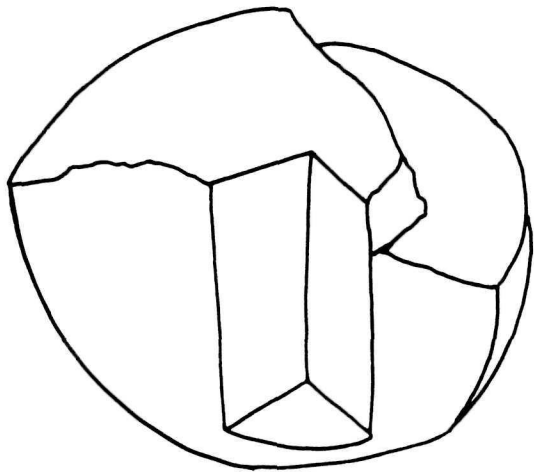
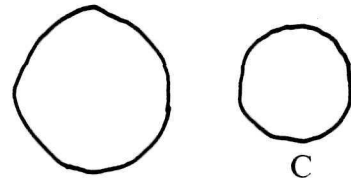

Figure 111. Cannon balls. (a,f) bar shot, (i) bar shot
bar? (b) grape shot, large, (c) grape shot, small,
(d) hollow shell, (e) British ordnance arrows, (g)
solid shot, broken, showing casting void, (h) solid
shot. Scale in cm.



A



B

C

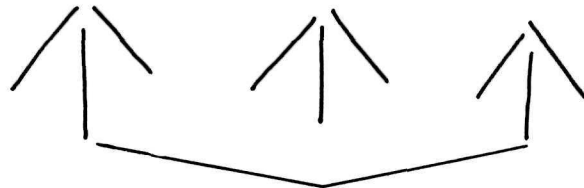

E

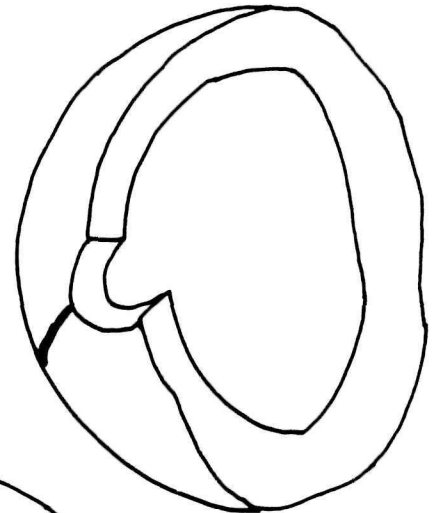

D

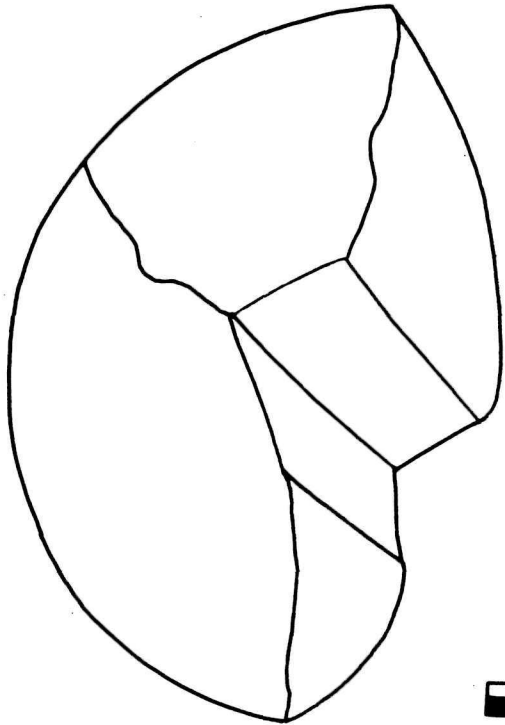

F

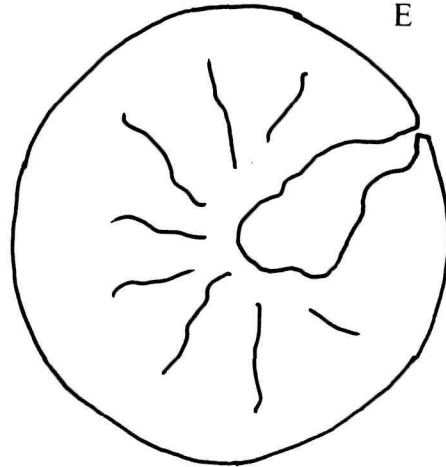

G

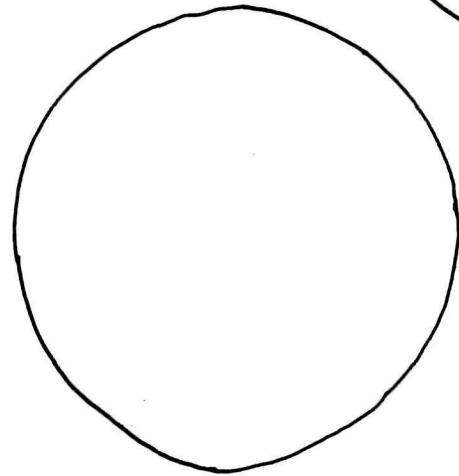

H

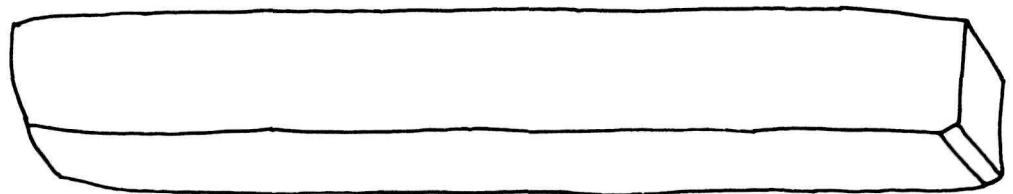

I



CM.

Figure 112. Military hardware and equipment. (a,d) eye bolts from cannon carriages, (b,c) wormers. Scale in cm.

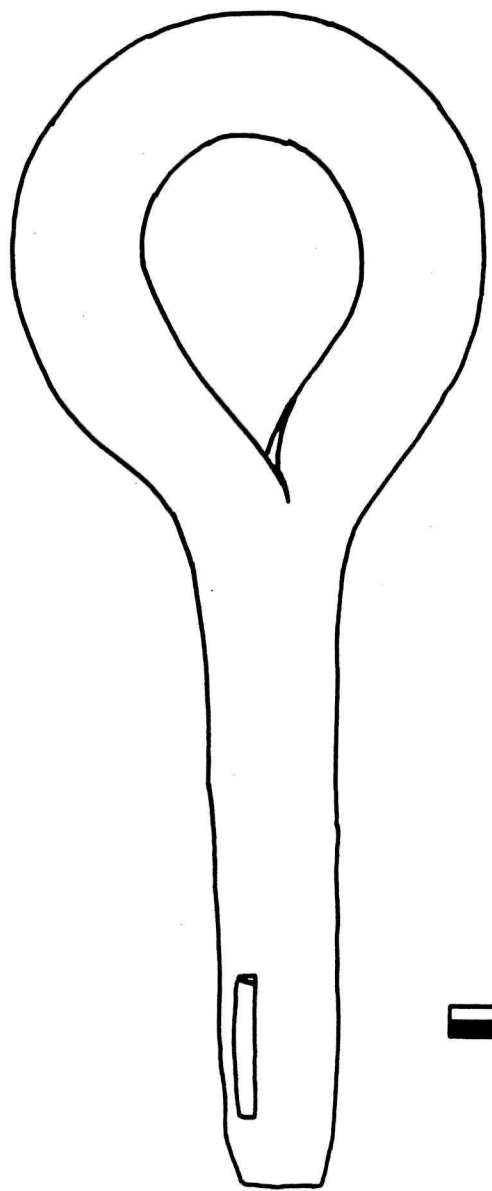

A

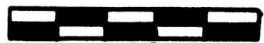

CM.

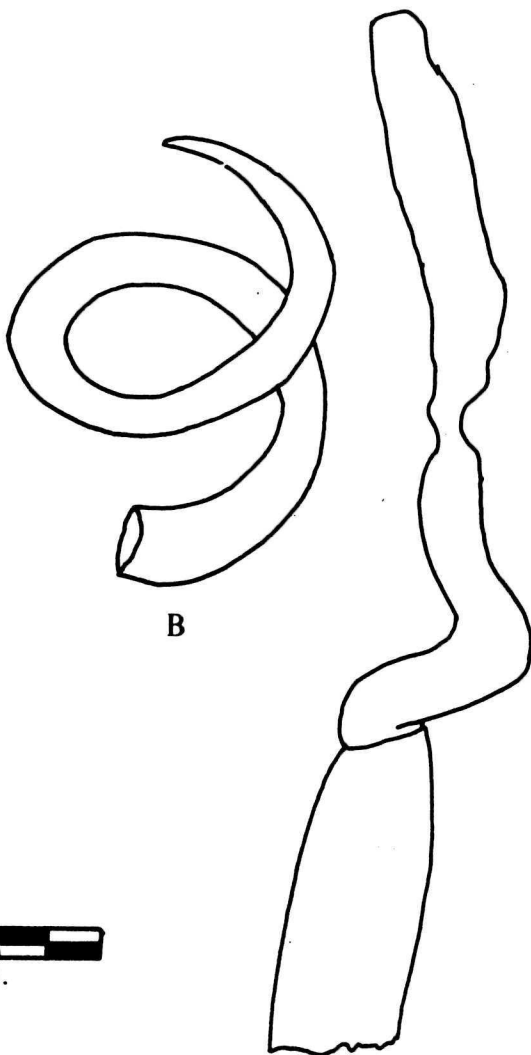

B



C

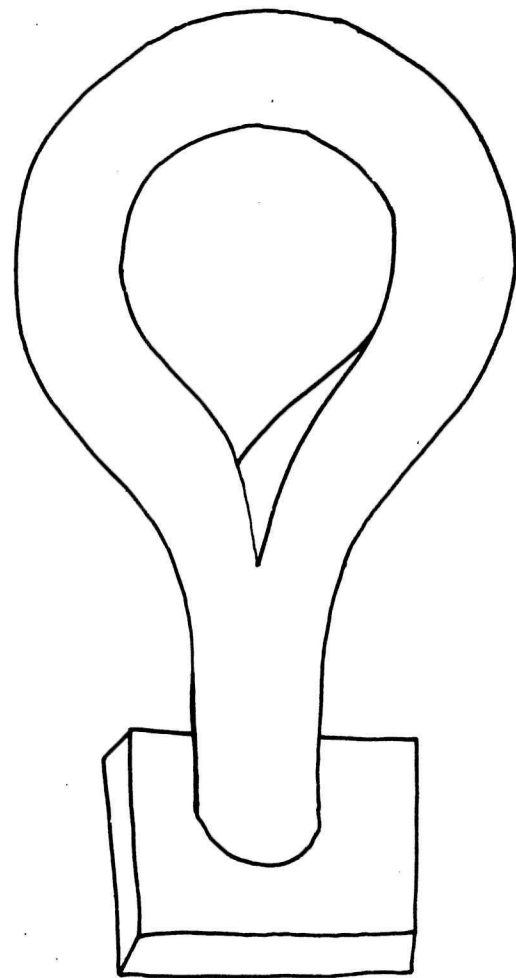

D

Figure 113. Military hardware and equipment. (a) side hook, (b) friction primer, (c,d) lynch pins. Scale in cm.

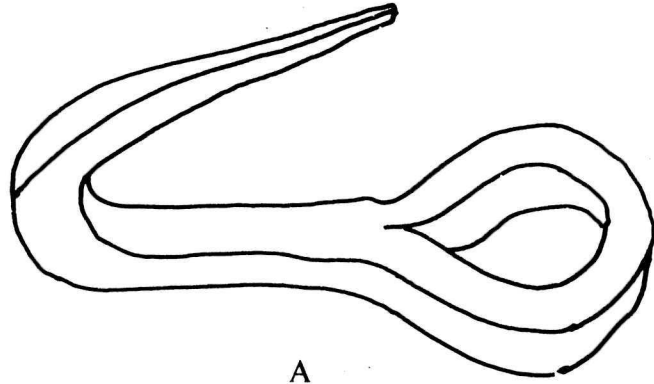

A

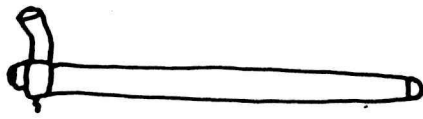

B

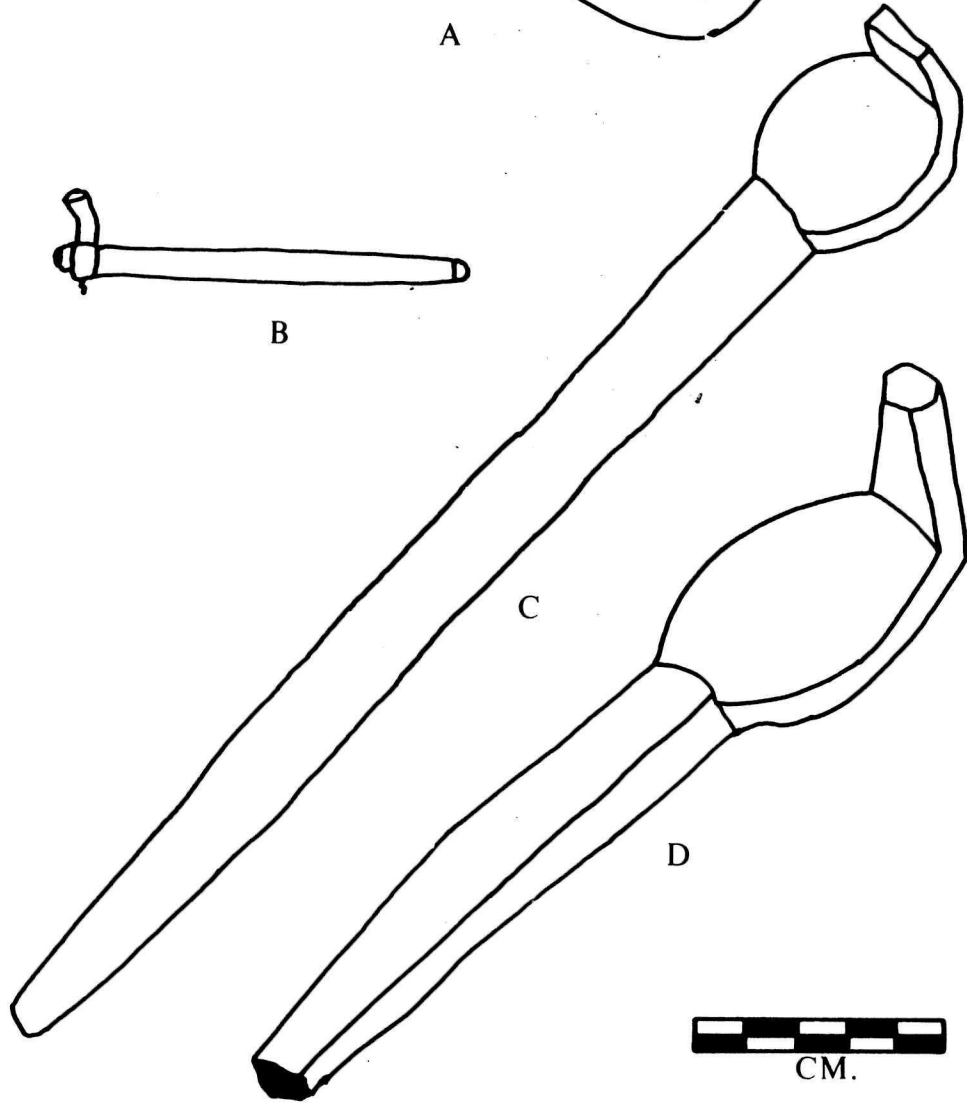

C

D



Figure 114. Military hardware and equipment. (a) trunnion cap, (b) side hook, (c) trunnion cap cotters and chain. Scale in cm.

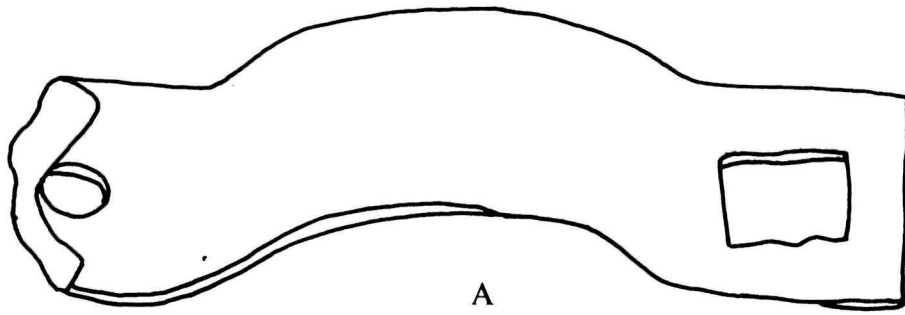

A



C

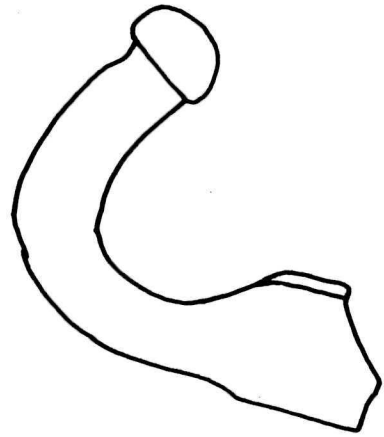

B

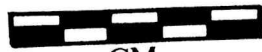
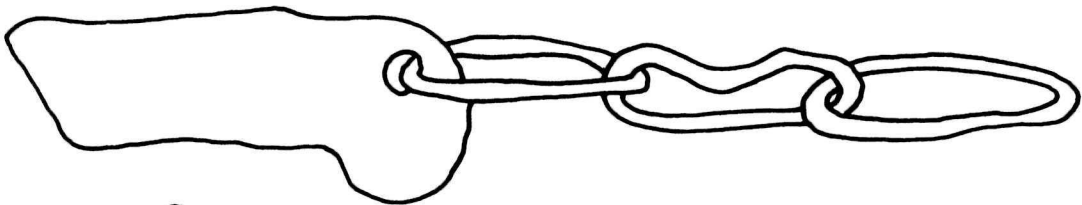

CM.

Figure 115. Iron tire for cannon carriage? Scale
in cm.

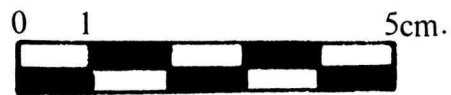
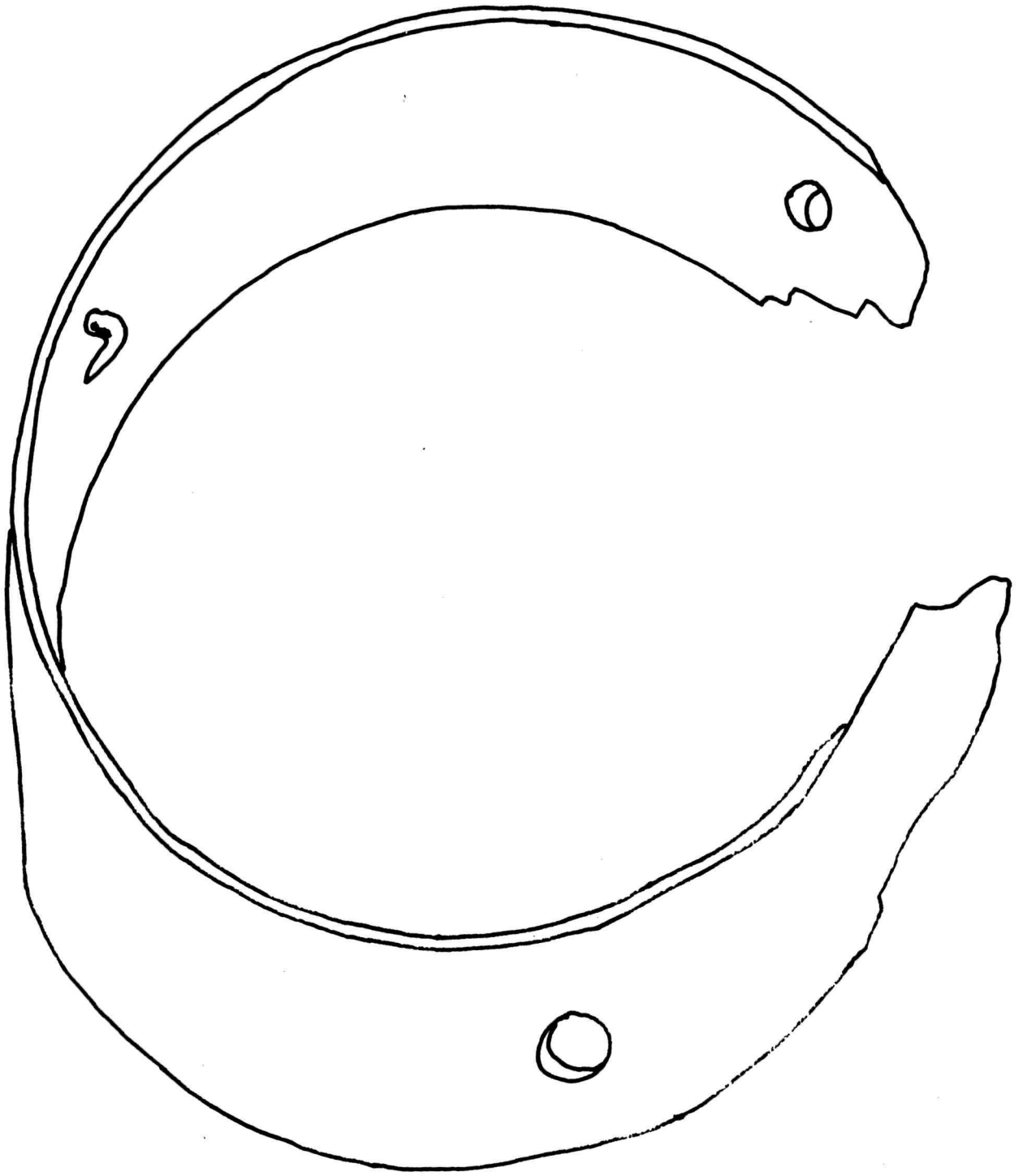
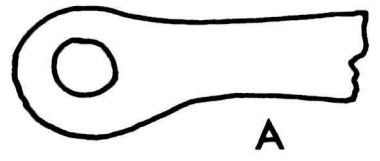

Figure 116. Military equipment. (a) brass side plate fragment, (b) cap screw, (c) wormer, (d) cock, (e) gun barrel. Scale in cm.



A



C

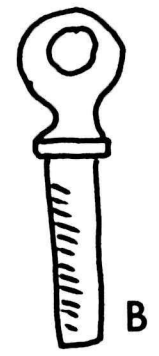

B

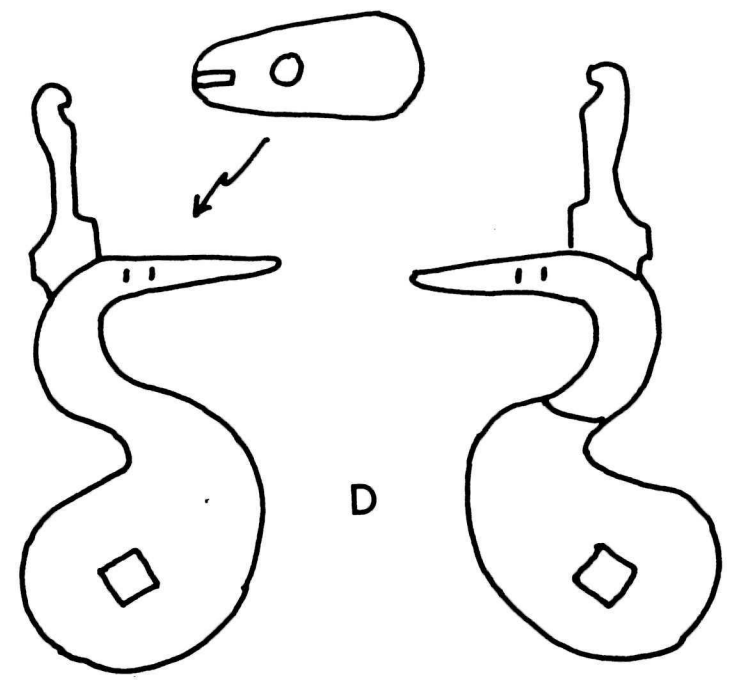

D

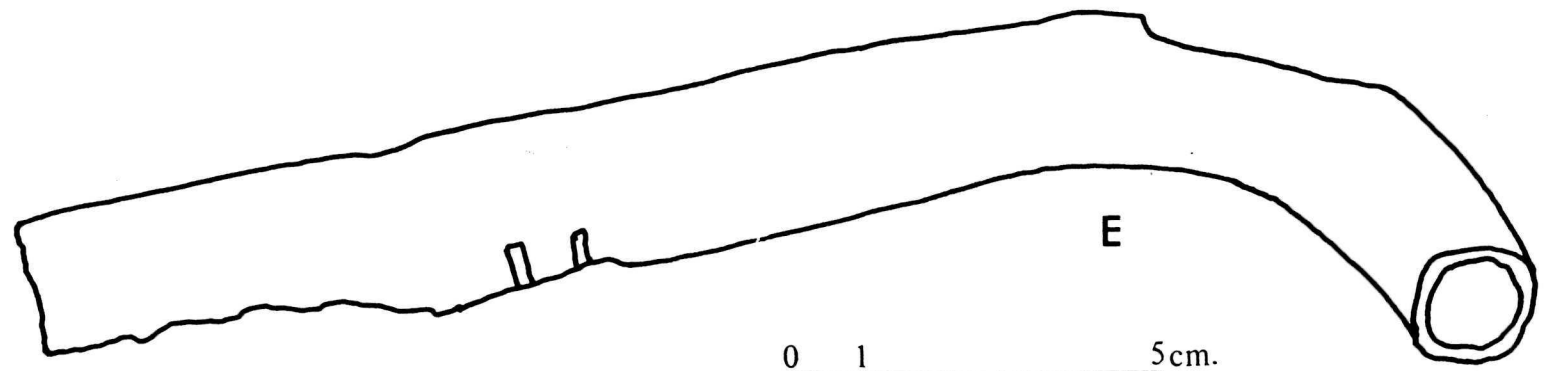

E

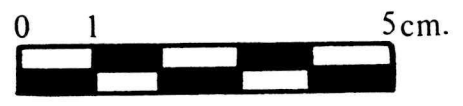

Figure 117. Gunflints. (a-c) prismatic, (d-j)
gunspall. Scale in cm.

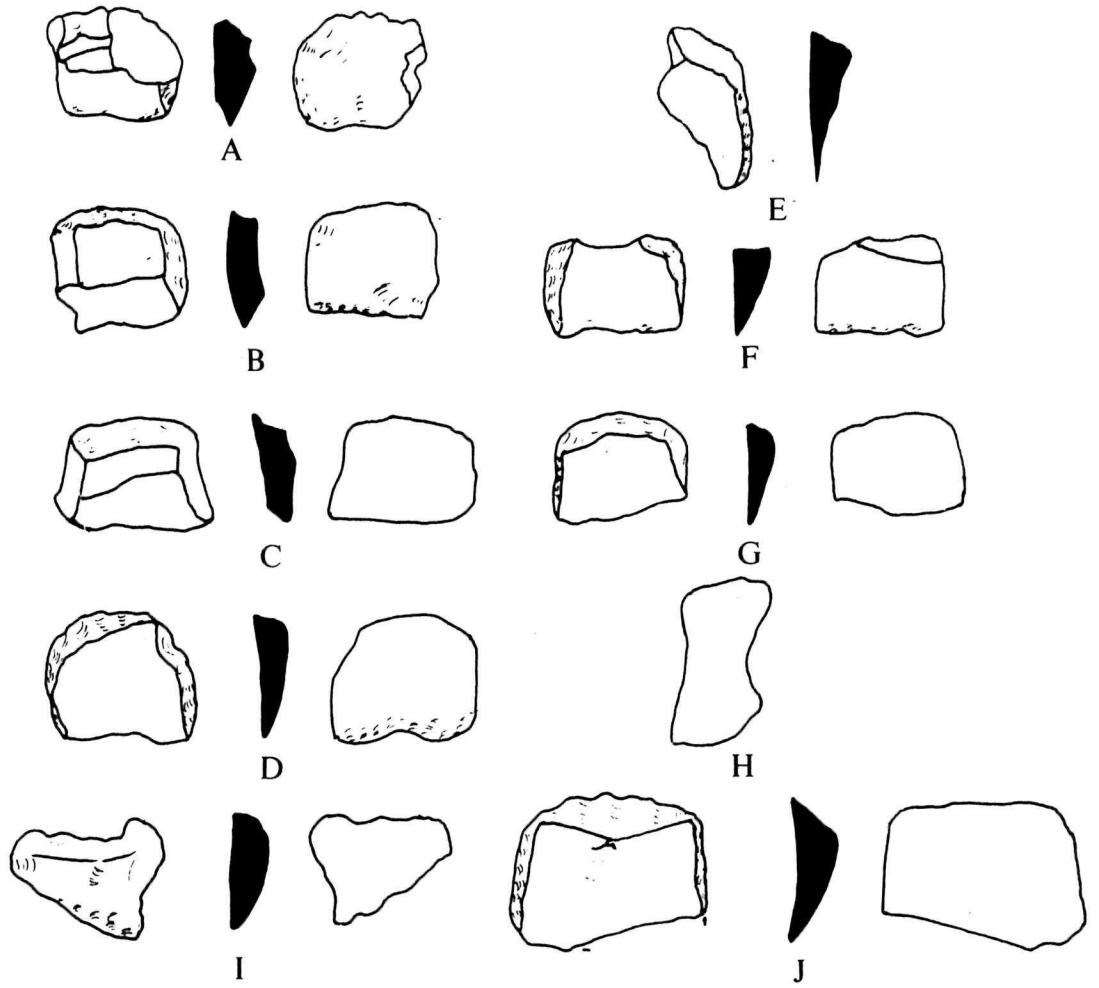
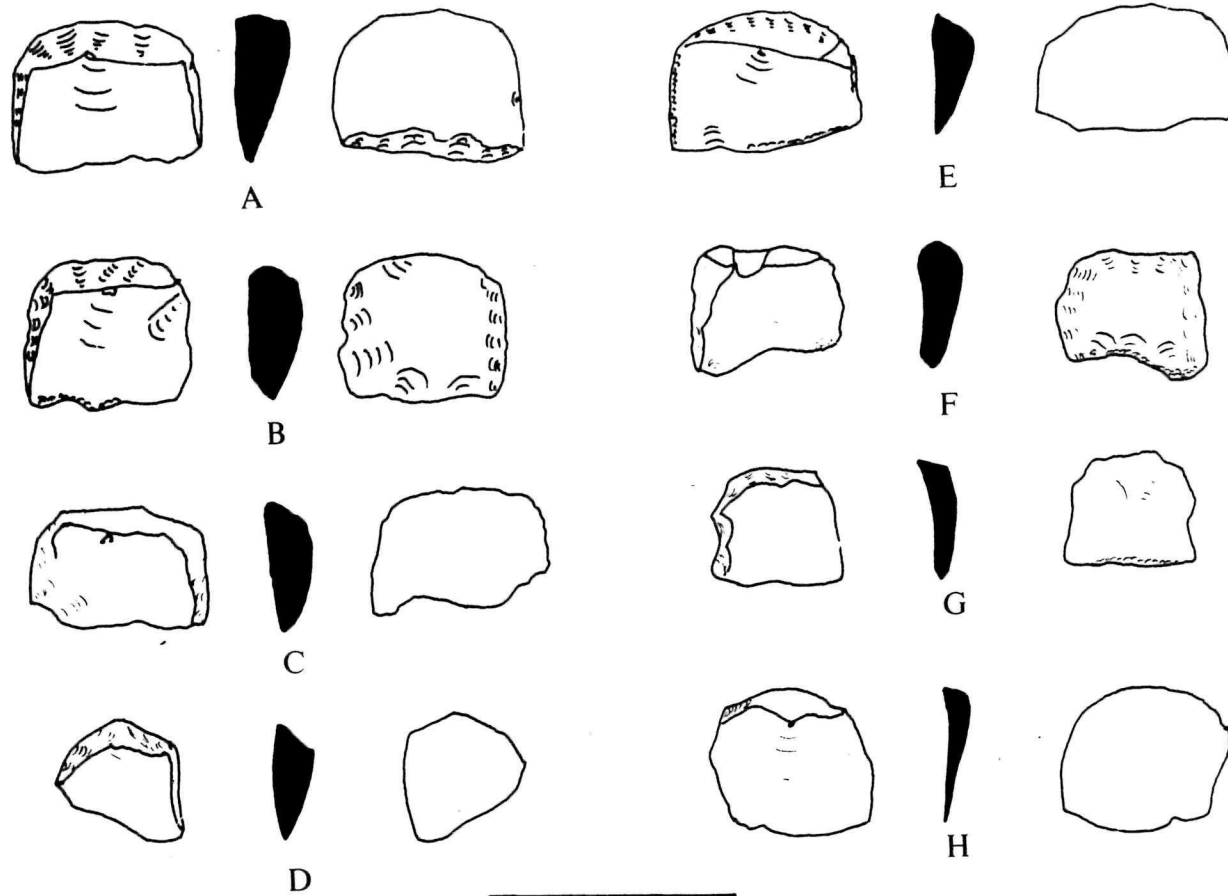
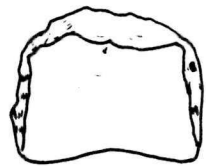

Figure 118. Gunflints. (a-h) gunspalls. Scale
in cm.



CM.

Figure 119. Gunflints. (a-g) gunspalls. Scale
in cm.



A

E



B

F



C

G

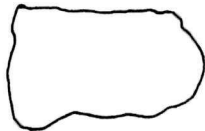
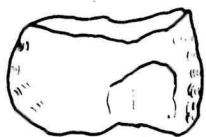

D

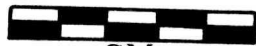

CM.

Figure 120. Flakes and strike-a-lights. (a-f) irregular flakes, (g,h) strike-a-lights, (i) large worked core. Scale in cm.

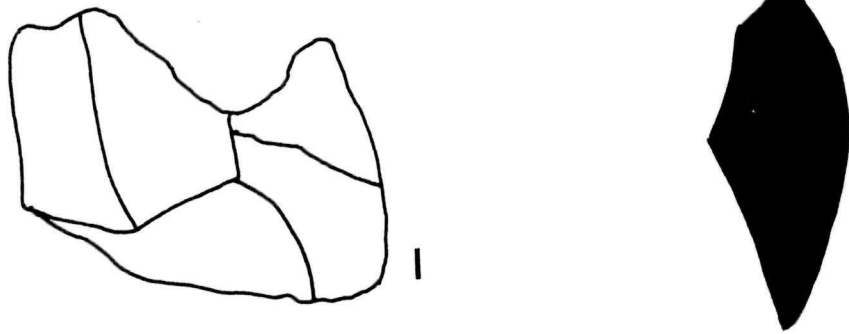
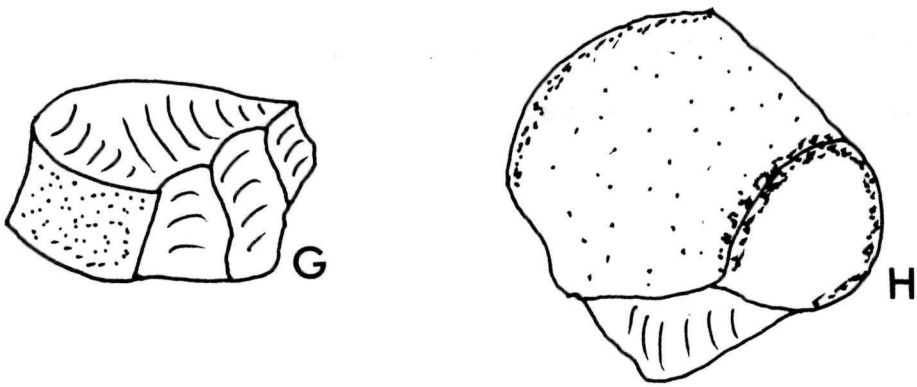
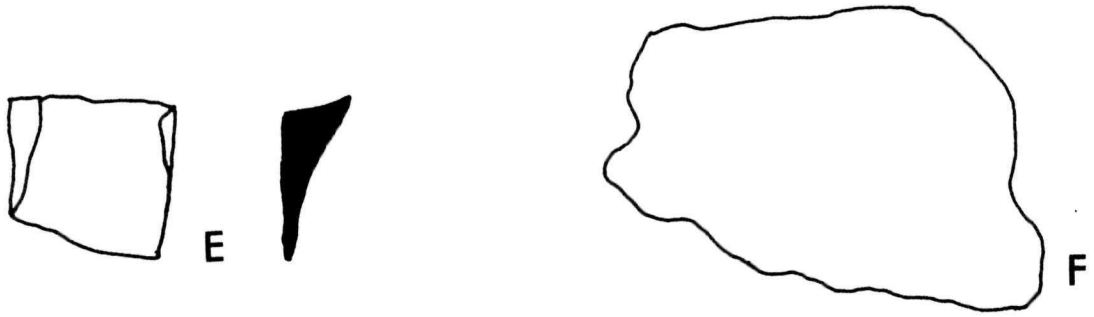
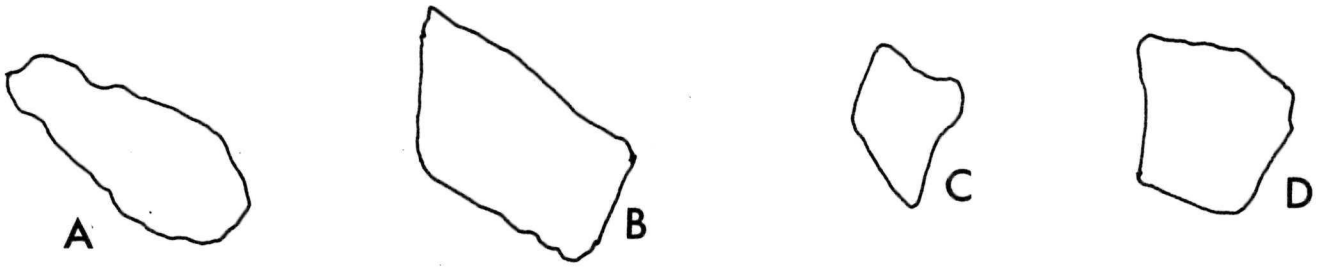

Figure 121. Military equipment. (a-c) sword frogs, (d) sword blade fragments, (e) knuckle bow, (f,g) shell counter guards, fragments. Scale in cm.

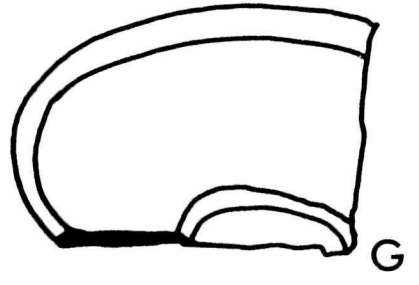
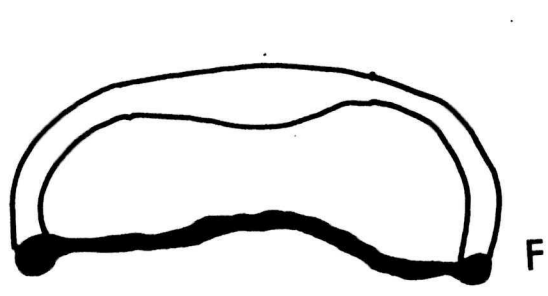
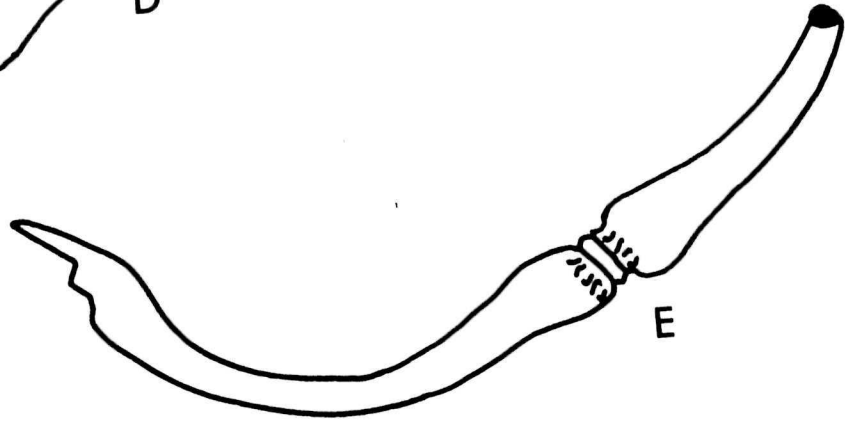
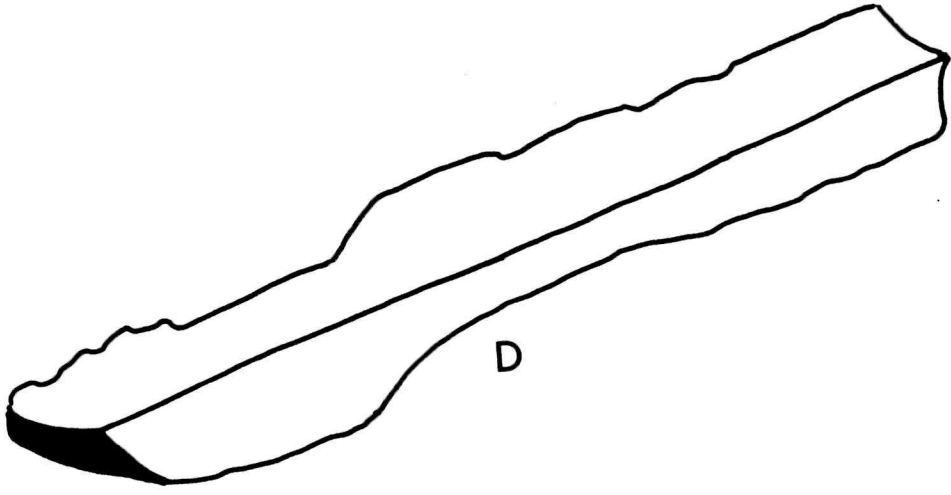
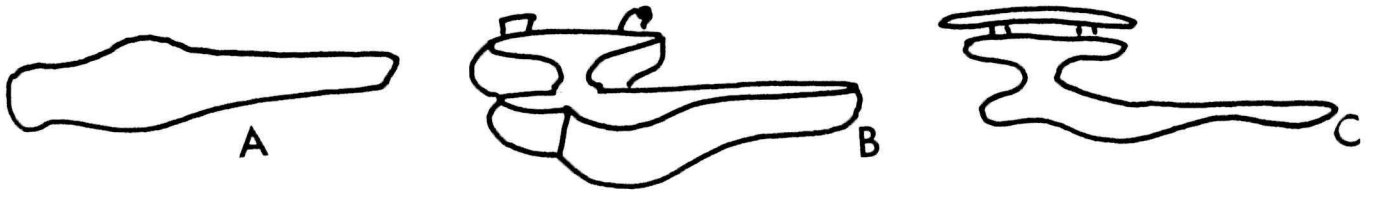
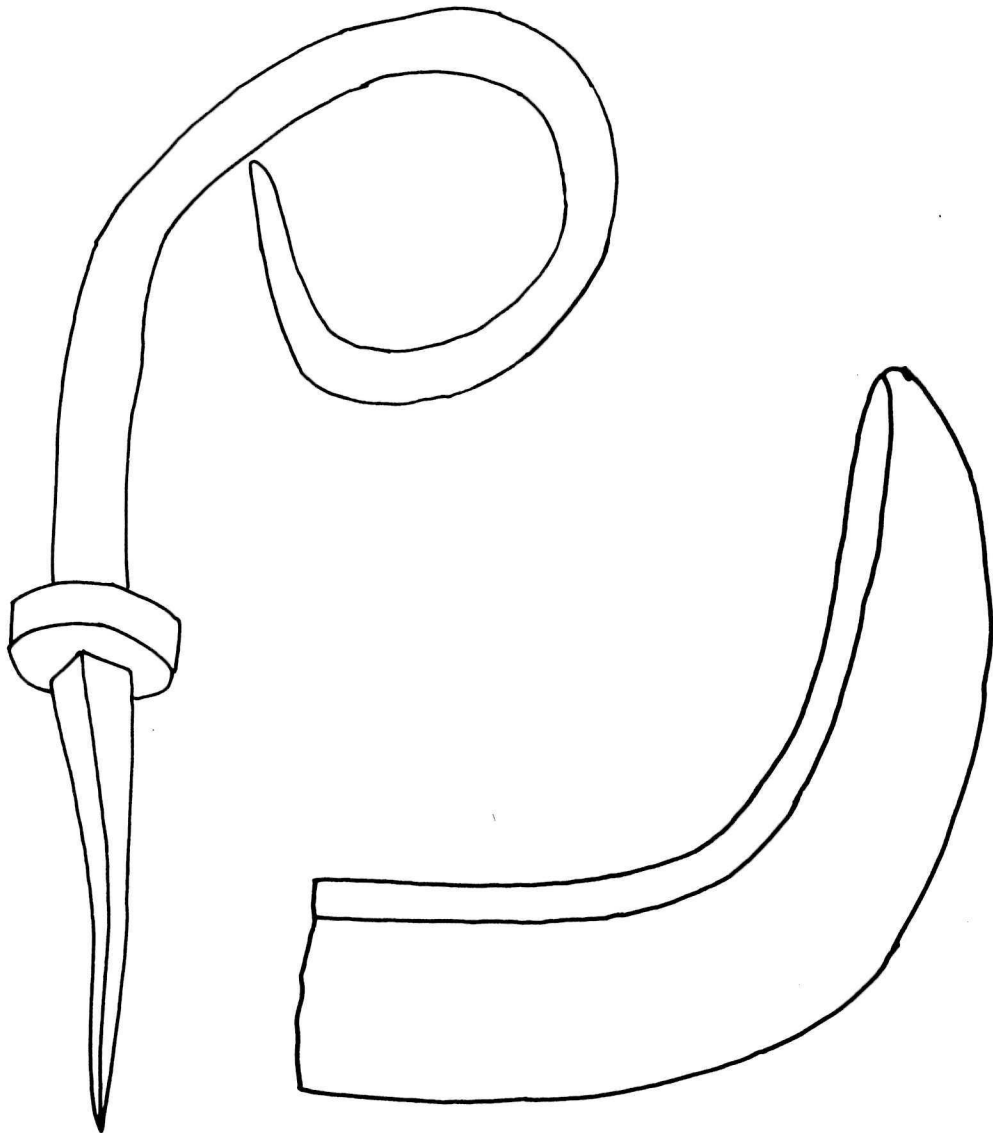
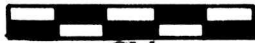

Figure 122. Military equipment, pole arms. (a)
bill, (b) pike. Scale in cm.



B

A



CM.

Figure 123. Military equipment, pole arms: (a-c)
pikes. Scale in cm.

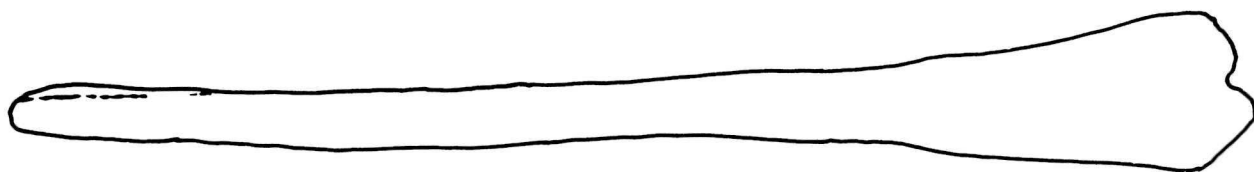

A

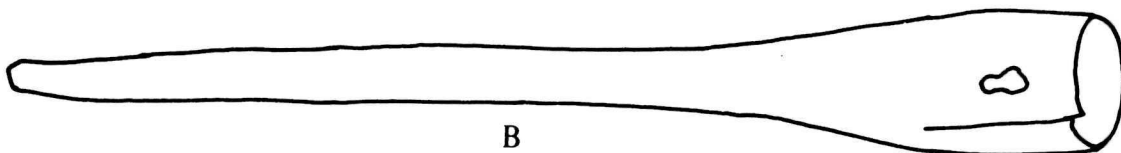

B

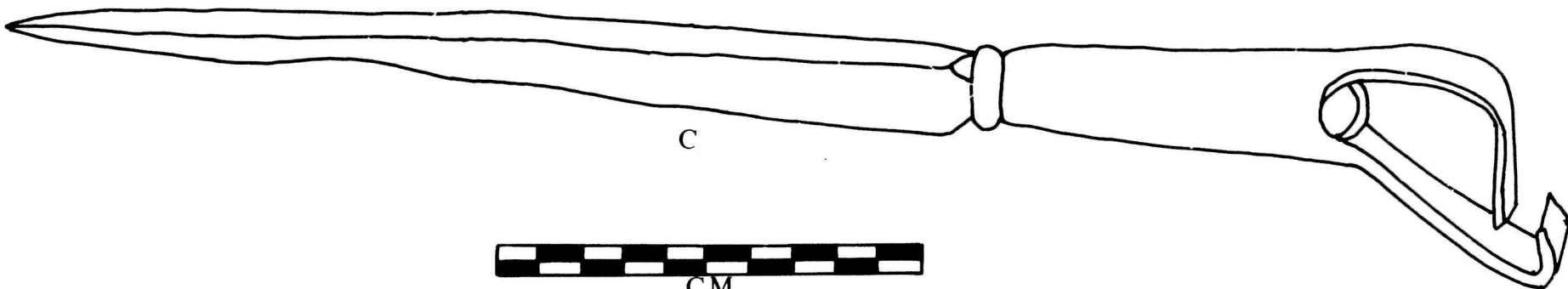

C

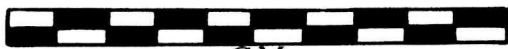

CM.

Figure 124. Tools. (a) large quarry wedge,
(b) sledge hammer, (c-e) chisels. Scale in cm.

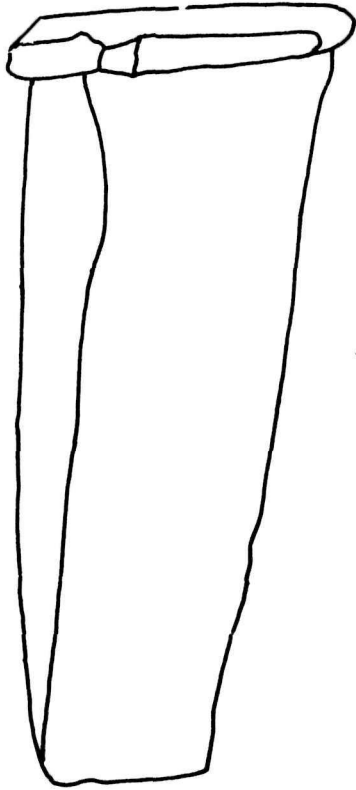

A

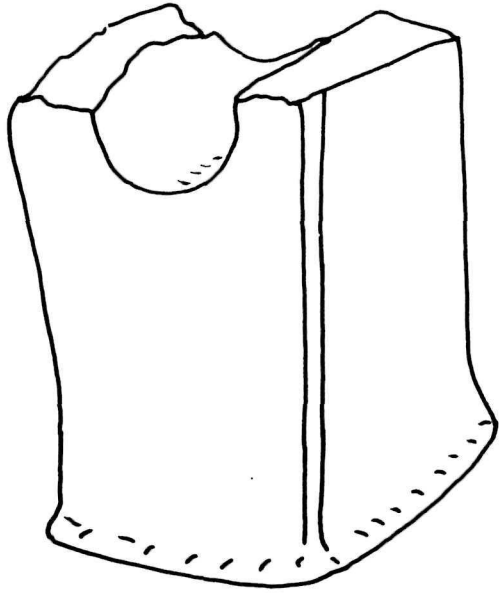

B

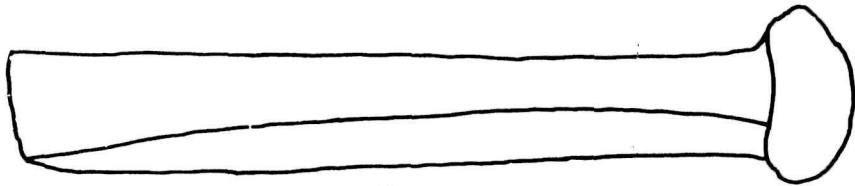

C

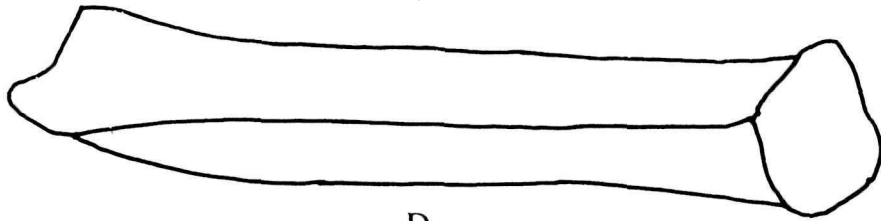

D

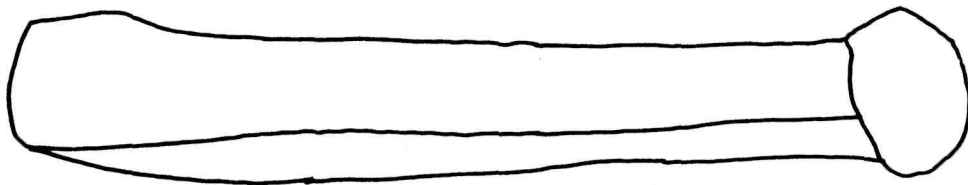

E

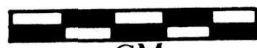

CM.

Figure 125. Tools. (a) quarry wedge, (b) wood splitting wedge. Scale in cm.

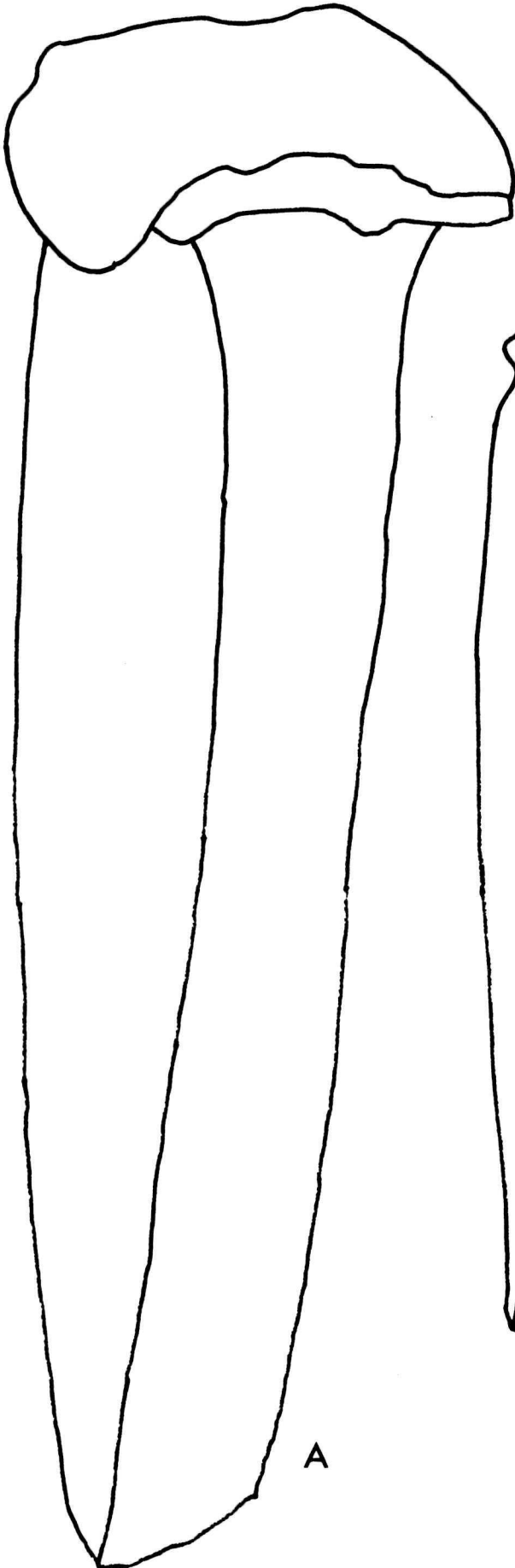

A

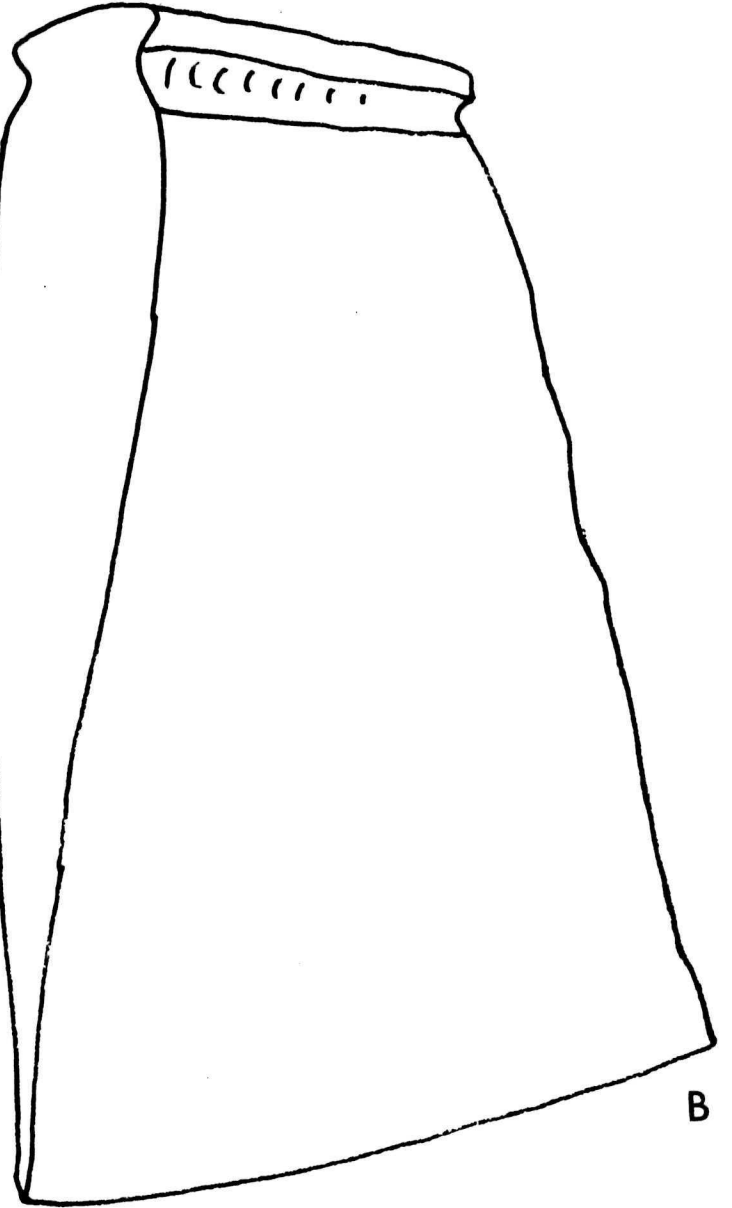

B

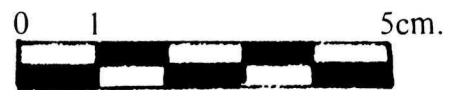
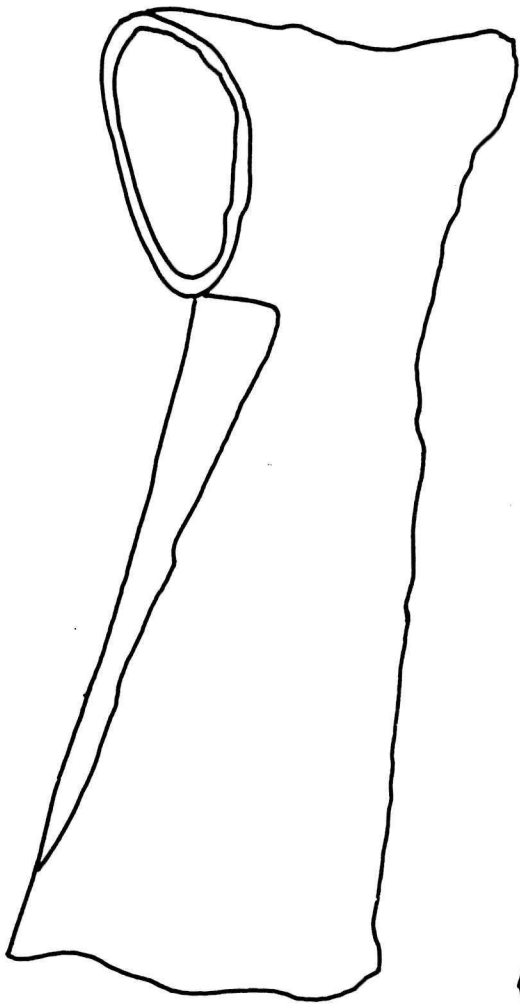
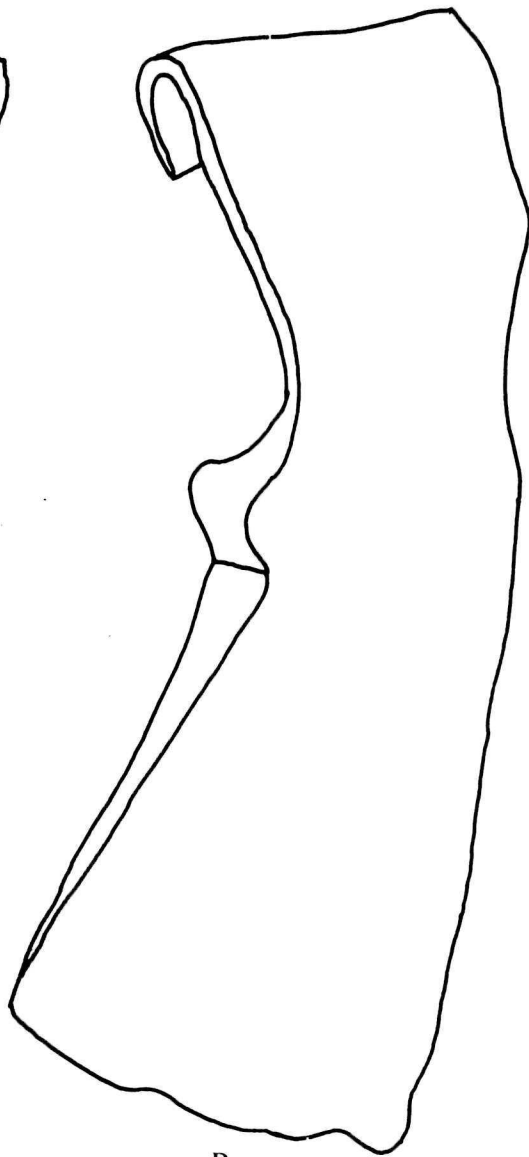

Figure 126. Tools. (a,b) French axes, (c) hafting socket, (d) socket of adz or hoe. Scale in cm.



A



B

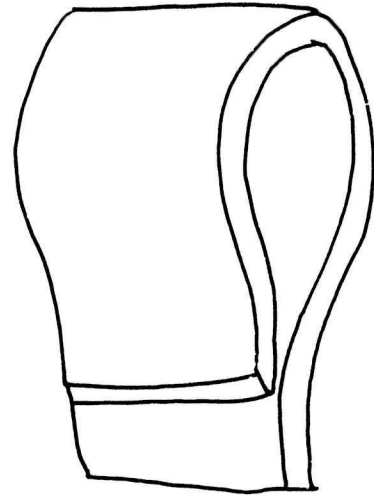

C

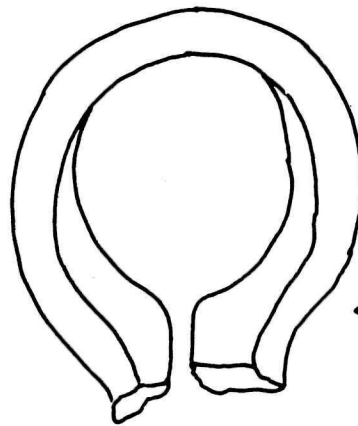

D

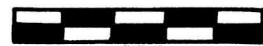

CM.

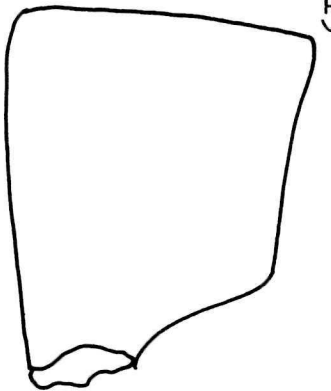

2015

Figure 127. Tools. English hewing axe. Scale
in cm.

2017

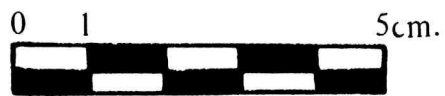
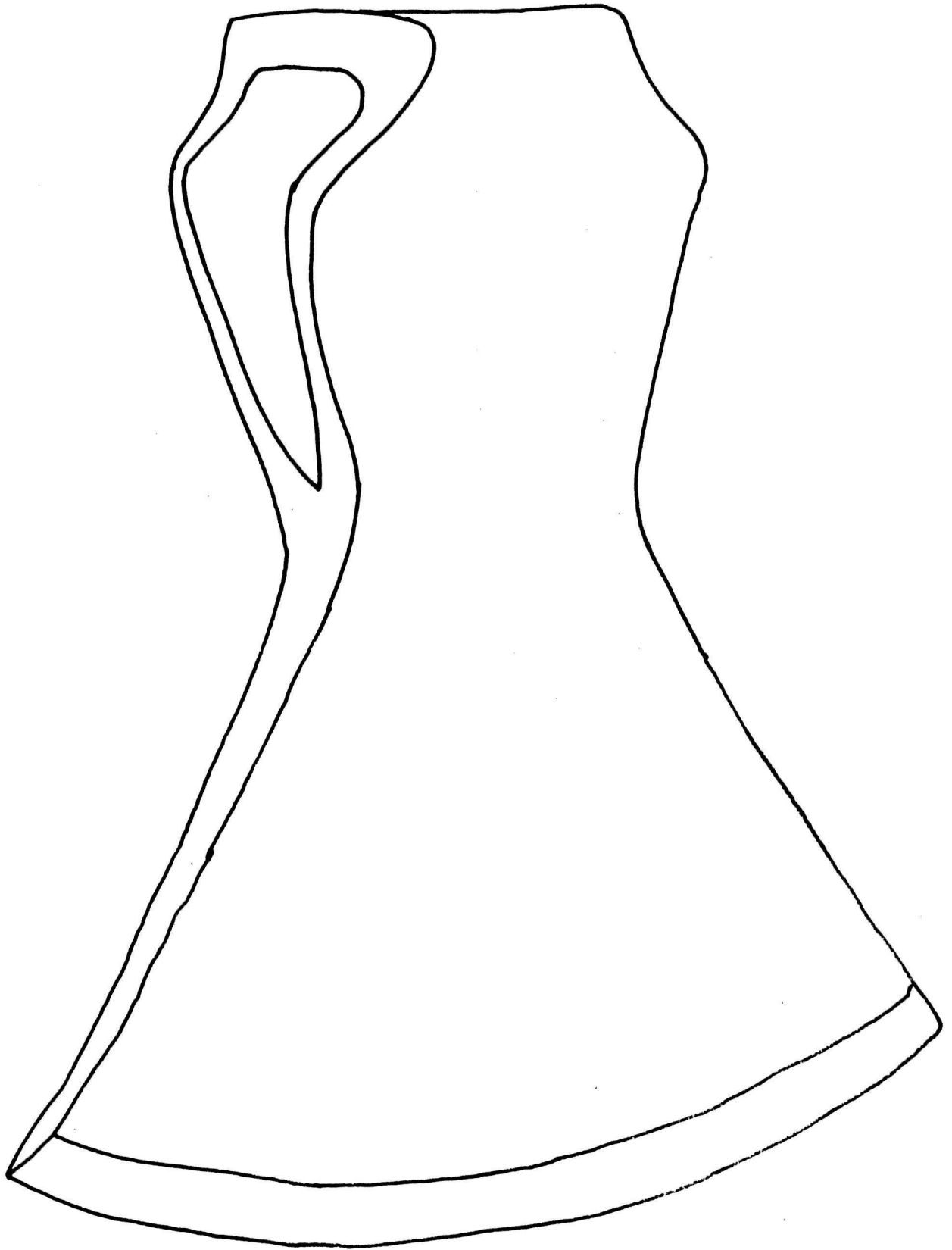

Figure 128. Tools. Pick blade fragments. Scale
in cm.

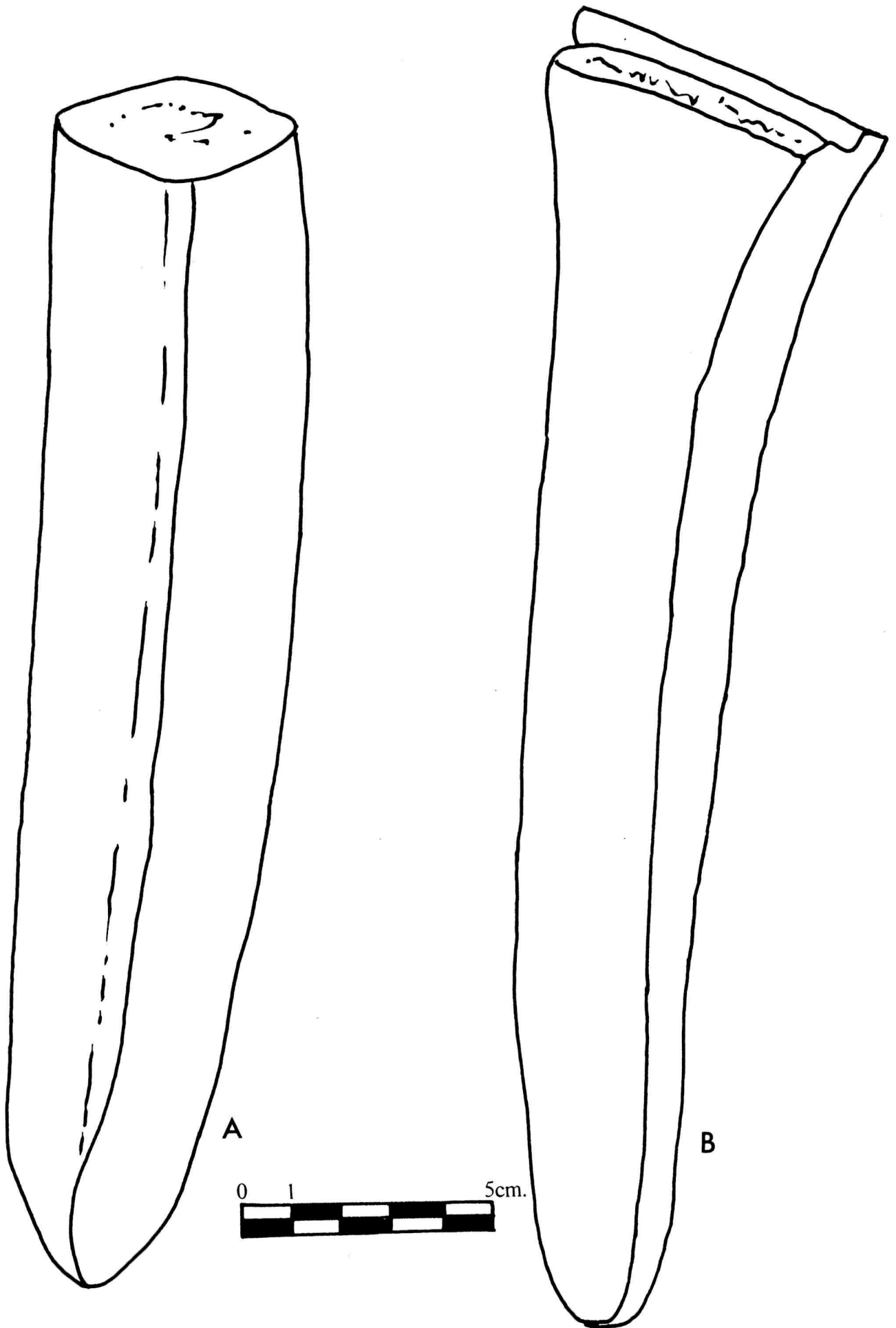
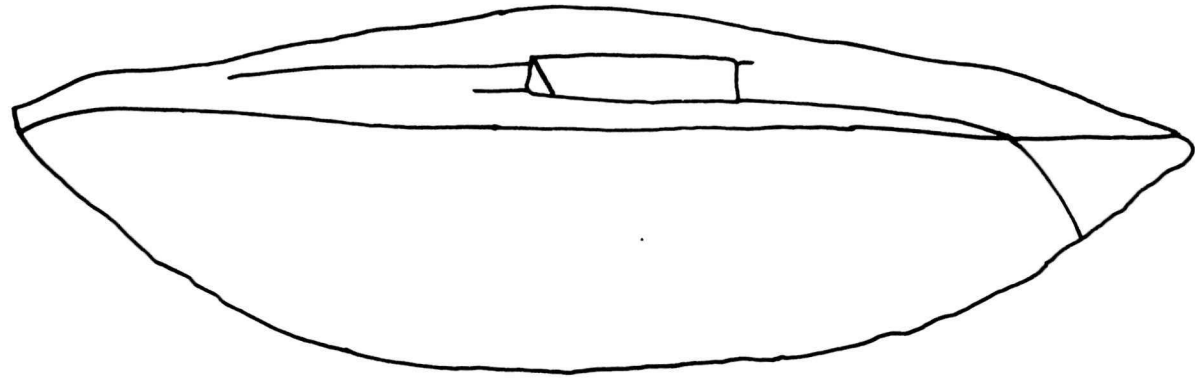
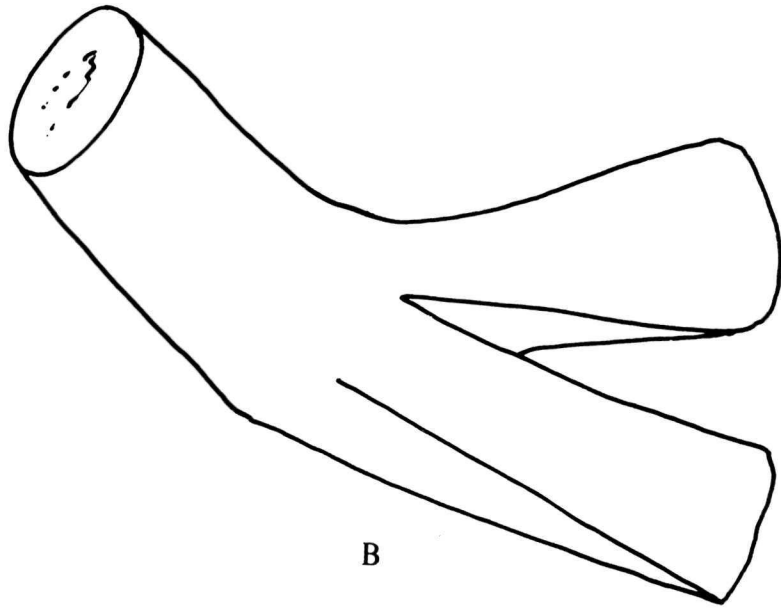

Figure 129. Tools. (a) marteau-a-deux-pointes;
mason's hammer, (b) crow or pry bar fragment.
Scale in cm.



A



B

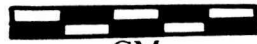

CM.

Figure 130. Tools. Shovels. (a) shank and handle socket of iron bladed shovel, (b,c,e) iron blades for wooden shovels, (d) iron spade. Scale in cm.

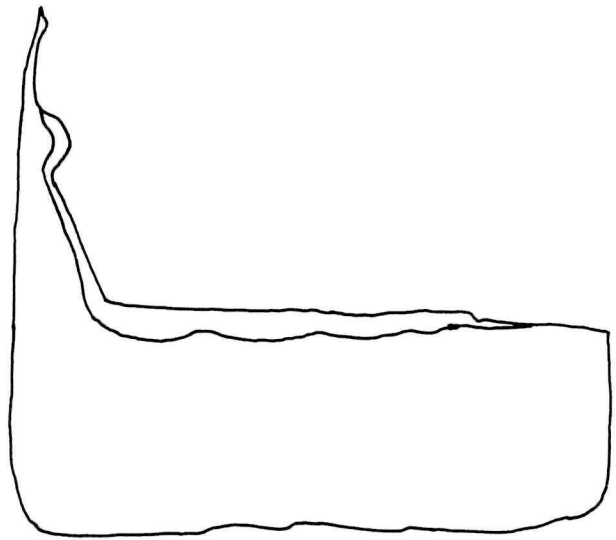

C

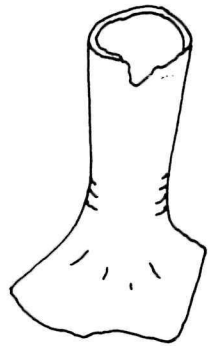

A



CM.

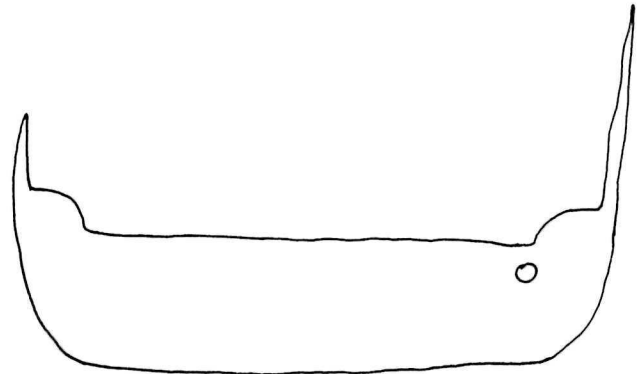

E

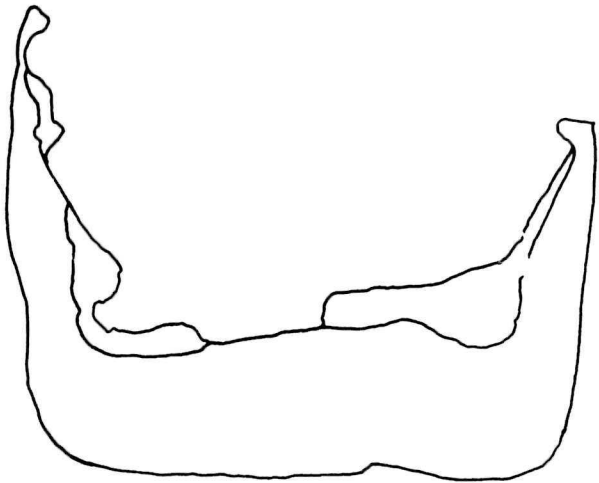

B



D

Figure 131. Tools. (a) saw blade fragment, (b,c)
mason's trowels. Scale in cm.

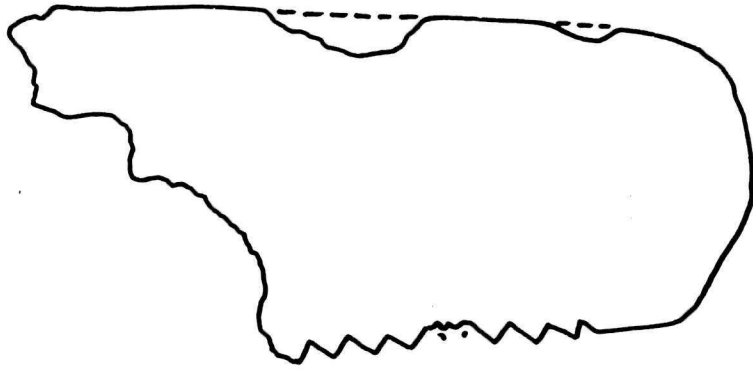

A

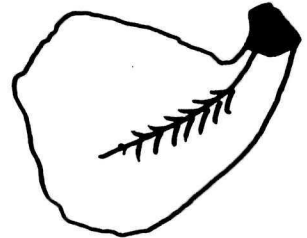

B

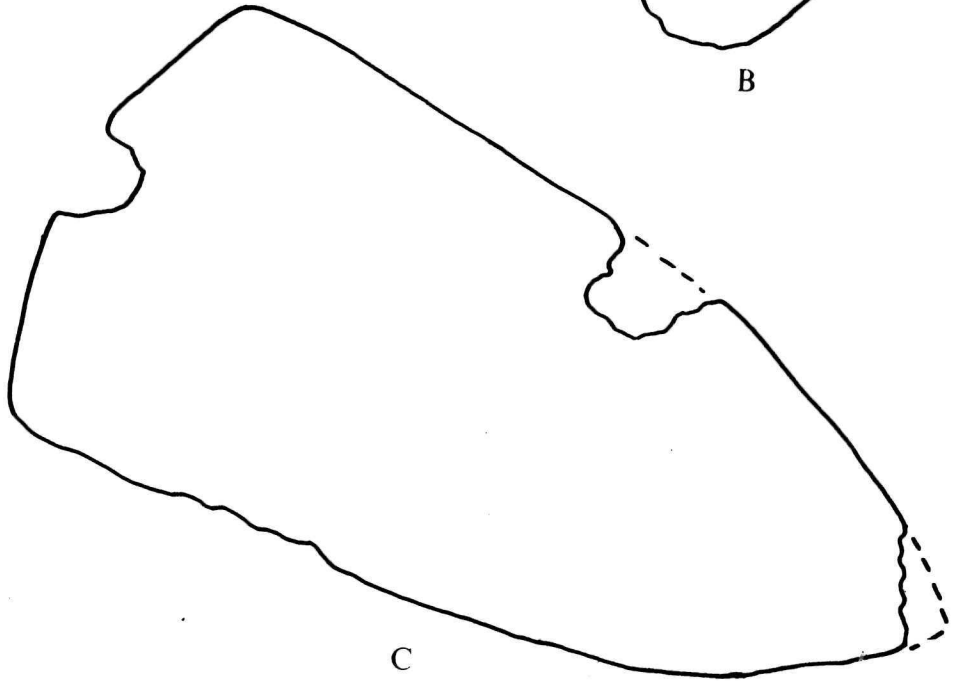

C

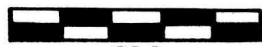

CM

Figure 132. Tools. (a,b) files, (c) rectangular file, (d,e) awls or punches, (f) sickle blade, (h) sickle blade, (g) whet stone. Scale in cm.

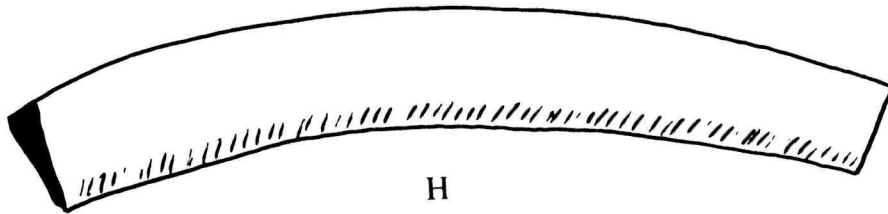
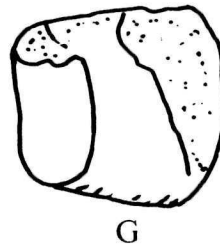
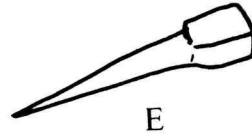
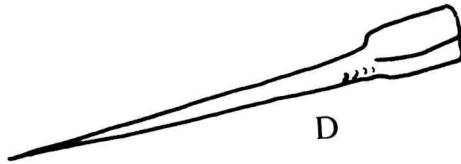
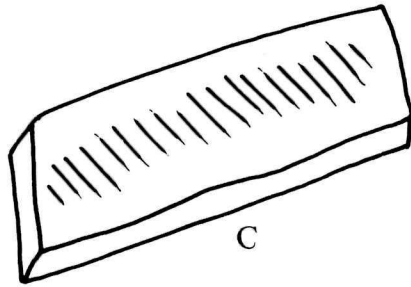
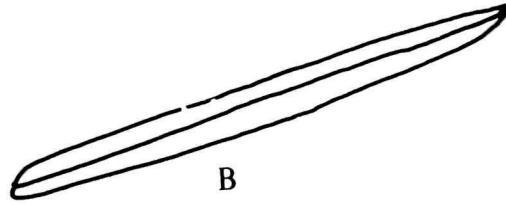
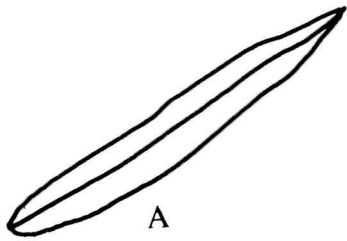

Figure 133. Fascine knife. Scale in cm.

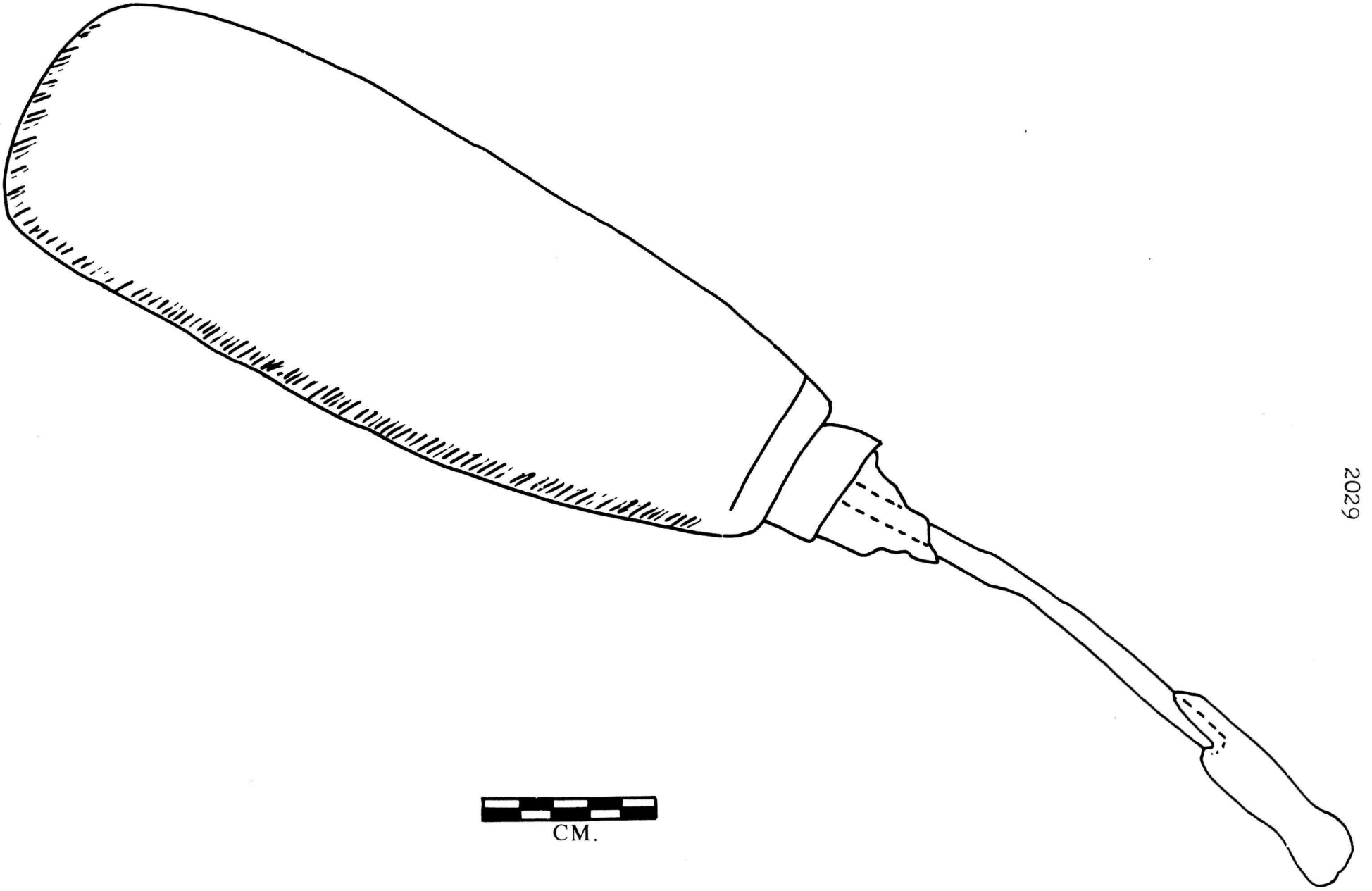

Figure 134. Scissors (a-p). Scale in cm.

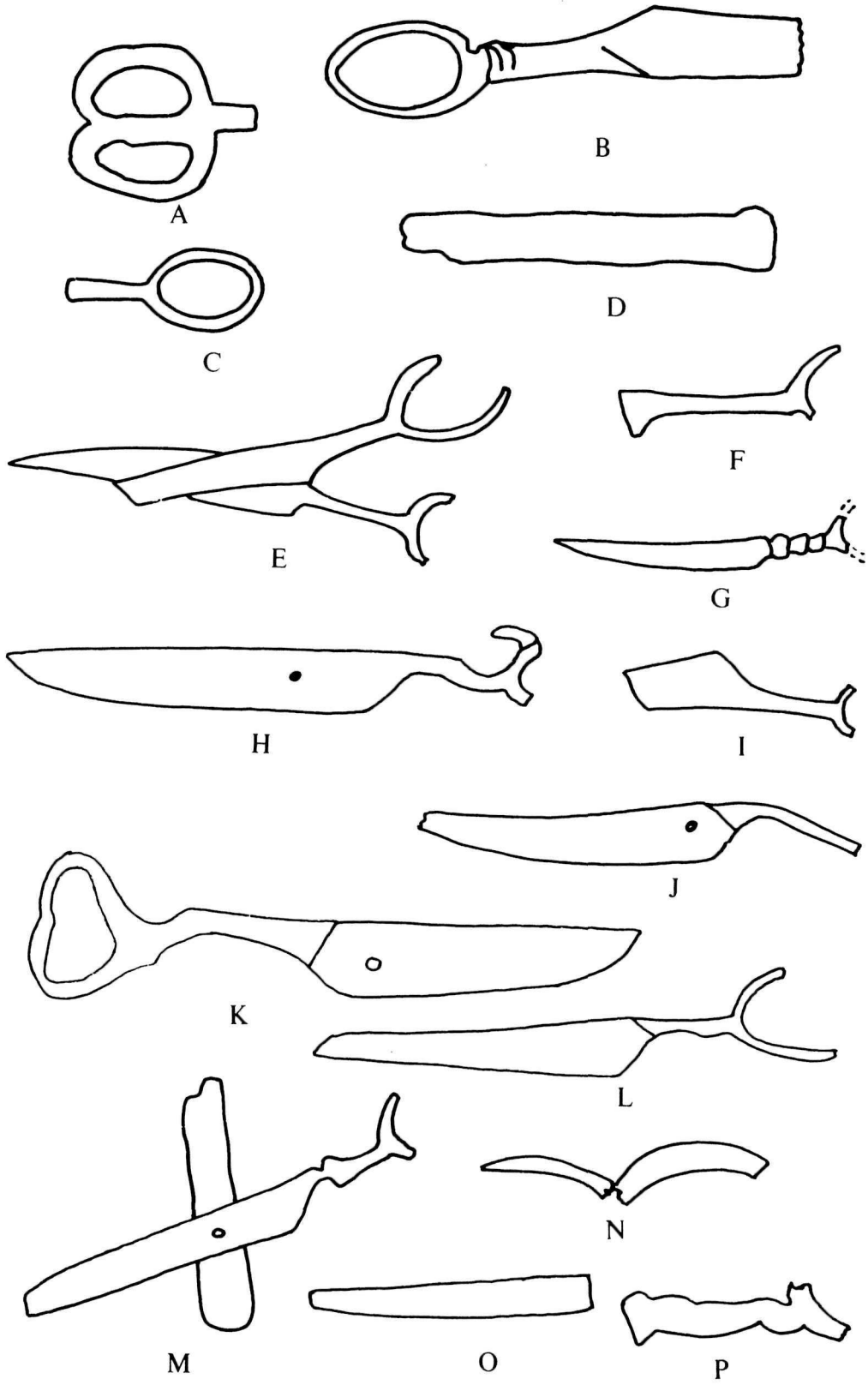

Figure 135. Iron kettle nearly restorable vessel profile. Scale in cm.

2033

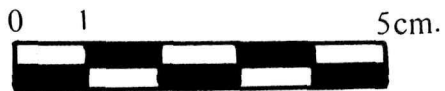
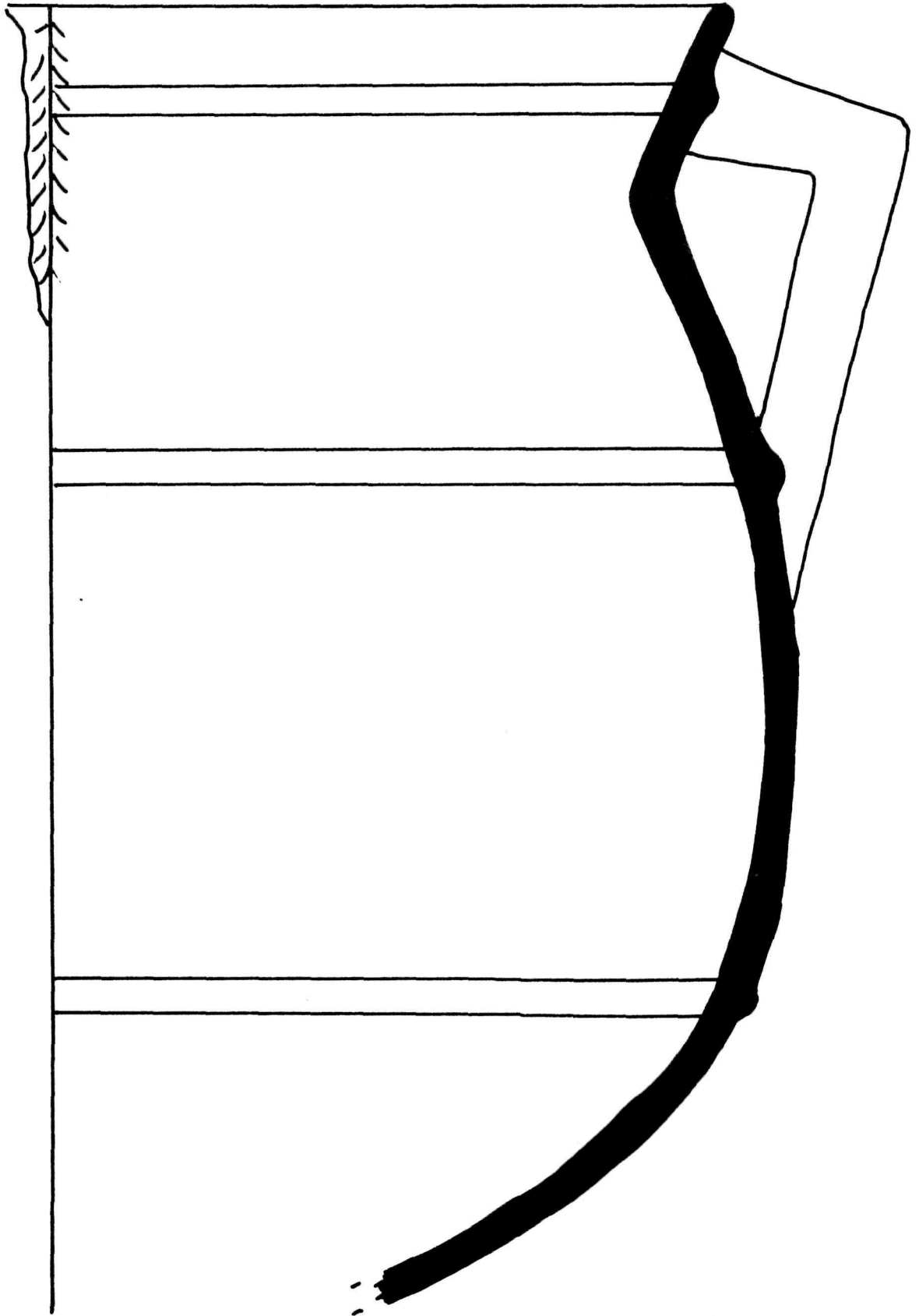

Figure 136. Iron kettle fragments. (a-e) rim profiles,
(f, g) legs. Scale in cm.

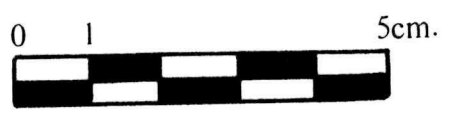
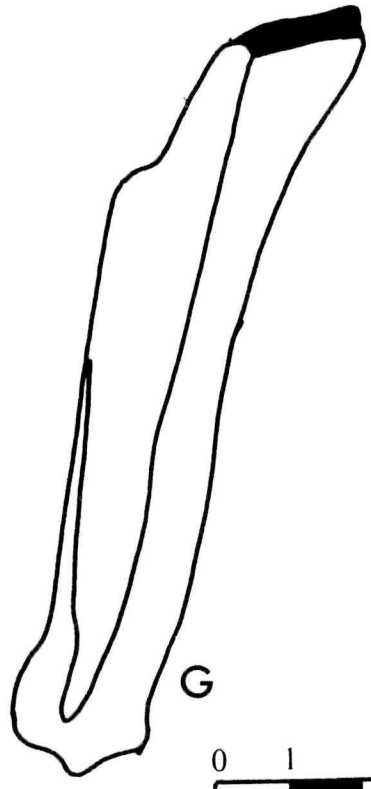
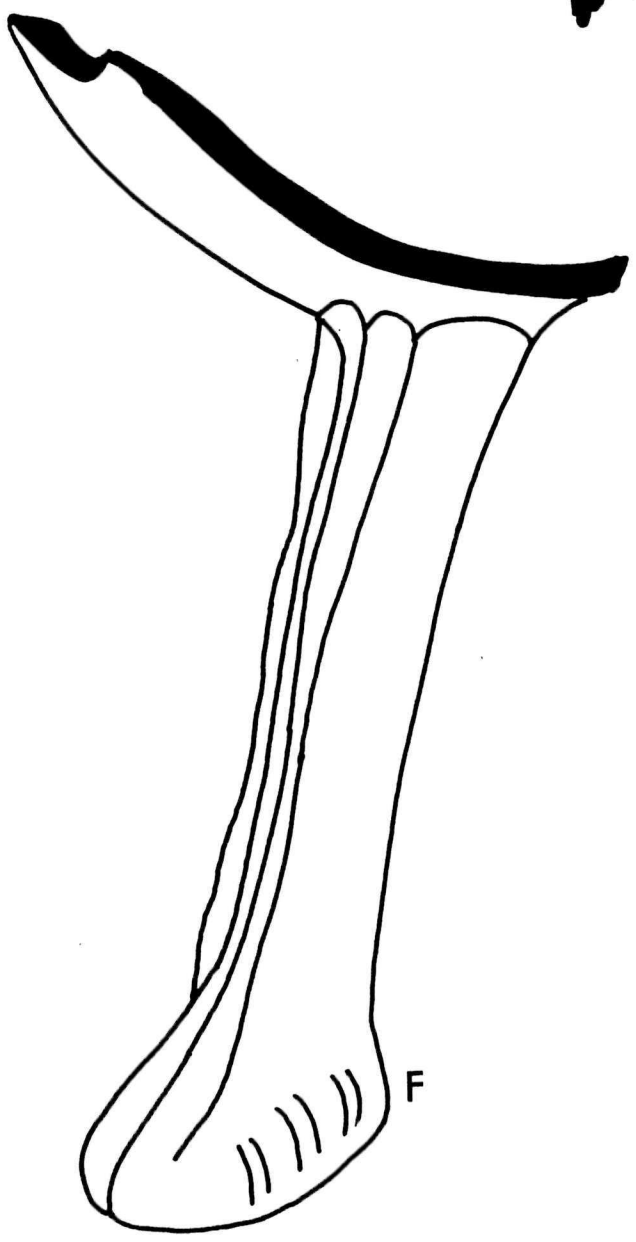
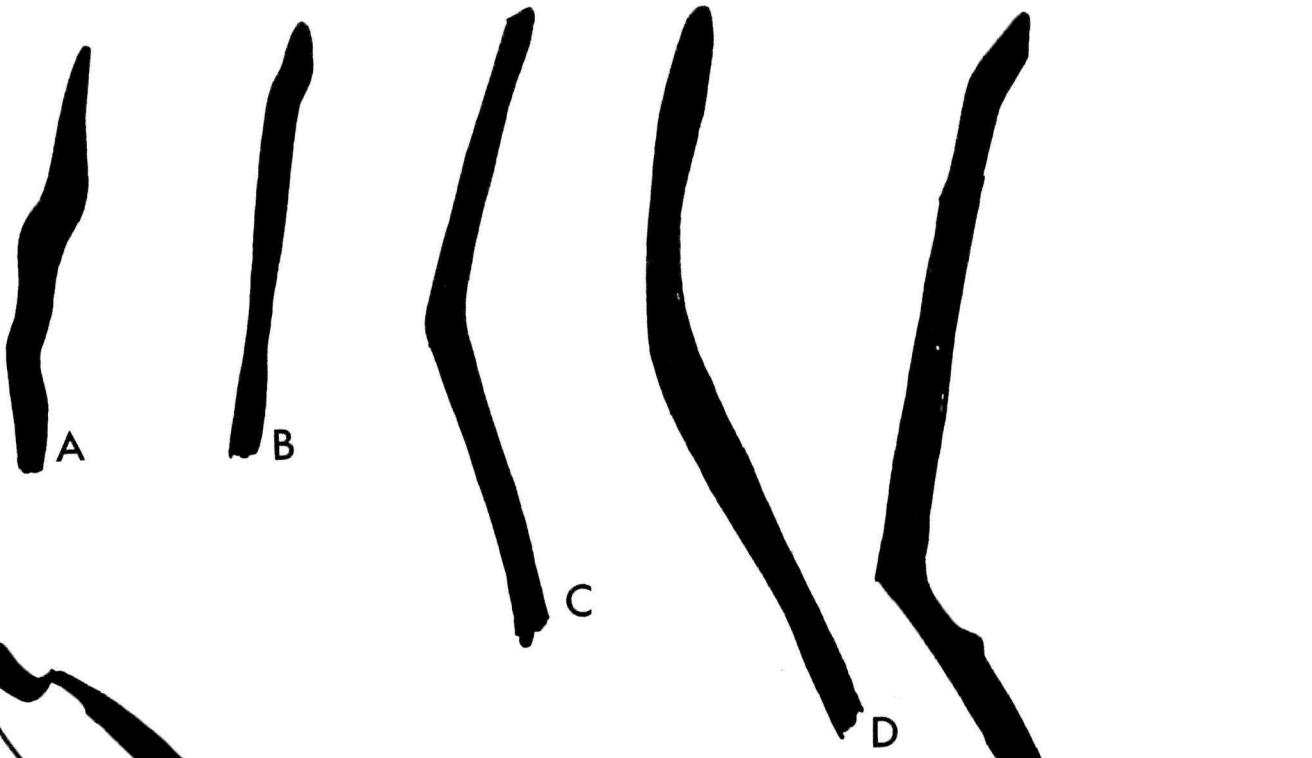
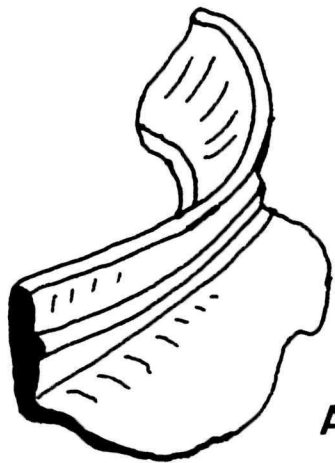
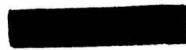

Figure 137. Iron kettles and pan. (a-c) kettle fragments, (d) long handled pan. Scale as shown.



A



5 cm.

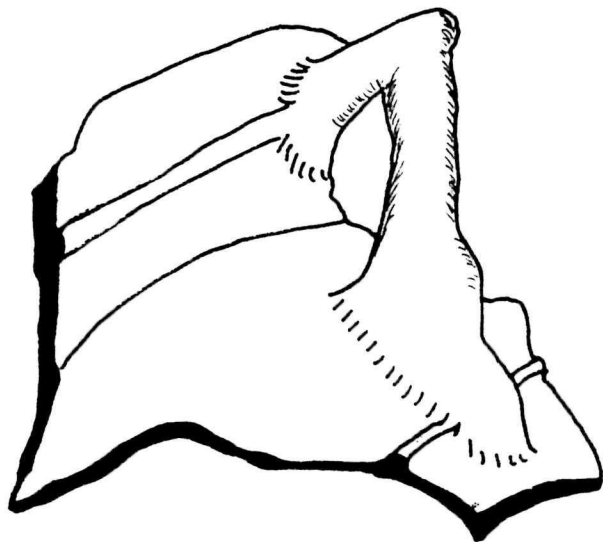

B

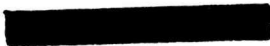

5 cm.



C

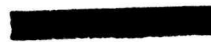

5 cm.

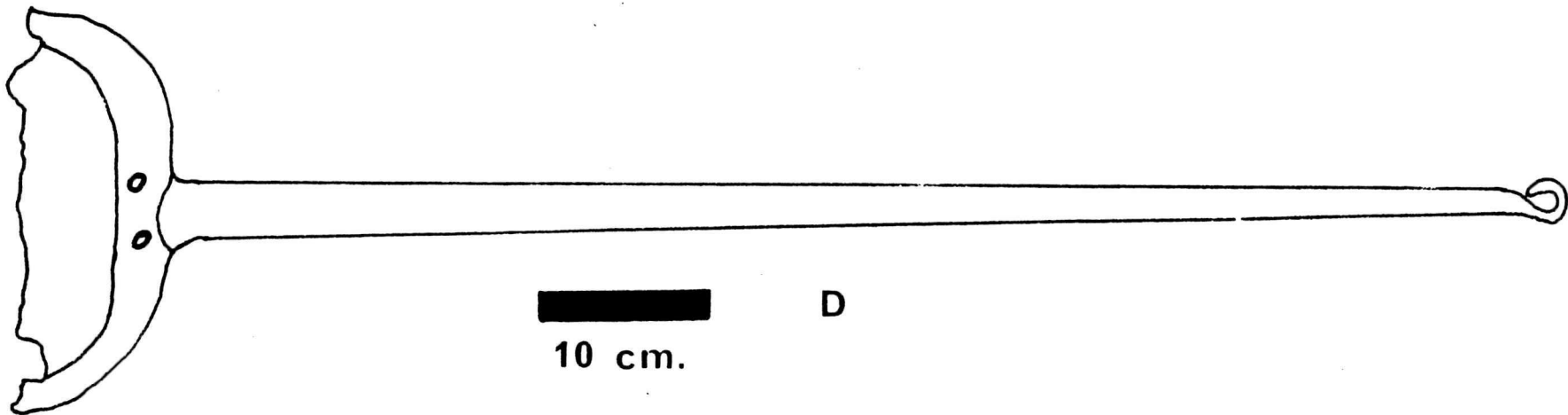

D



10 cm.

Figure 138. Utensils, knives. (a-e) blades, (f) handle, (g) tanged blade. Scale in cm.



A

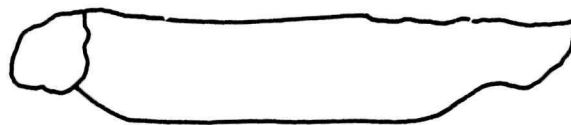

B



C

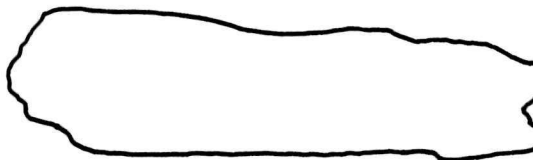

D



E



F

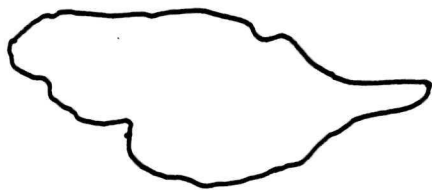

G

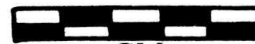

CM.

Figure 139. Utensils, knives. (a-f) clasp knives.
Scale in cm.

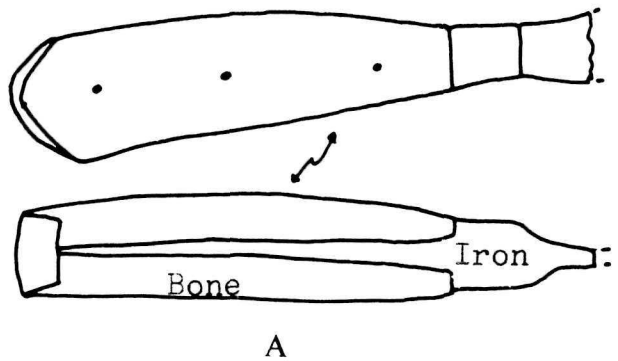

A

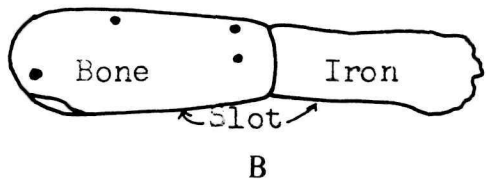

B

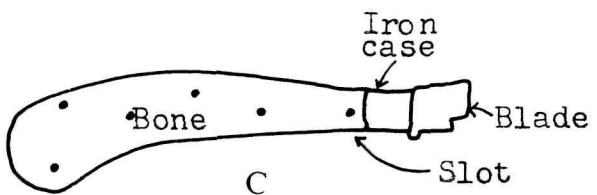

C

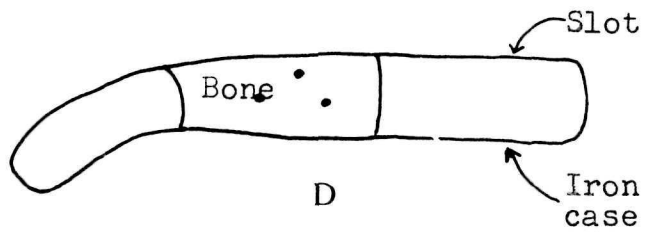

D

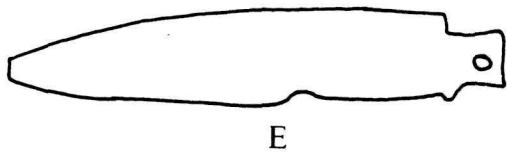

E

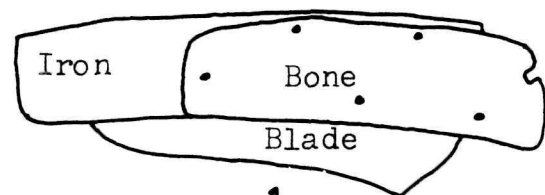

F

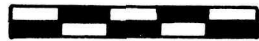

CM.

Figure 140. Forks and spoons. (a-d) forks,
(e-g) spoon fragments. Scale in cm.



A



B



C



D

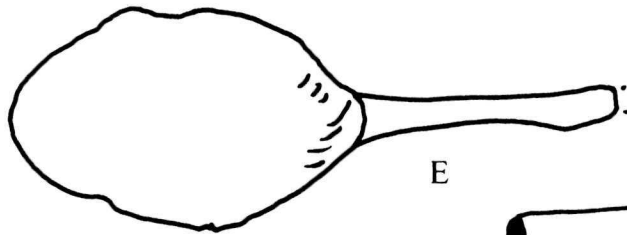

E



F

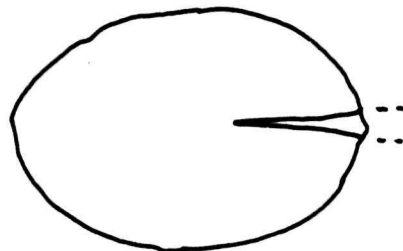

G



CM.

Figure 141. Buttons. Button types: (a) A1, (b) B2, (c) B3, (d) B4, (e) B5, B6, (f) B5, (g) B6, (h) C7, (i) D8, (j) D9, (k) D10, (l) D11, (m) D12, (n) E13, (o) E14, (p) F15.

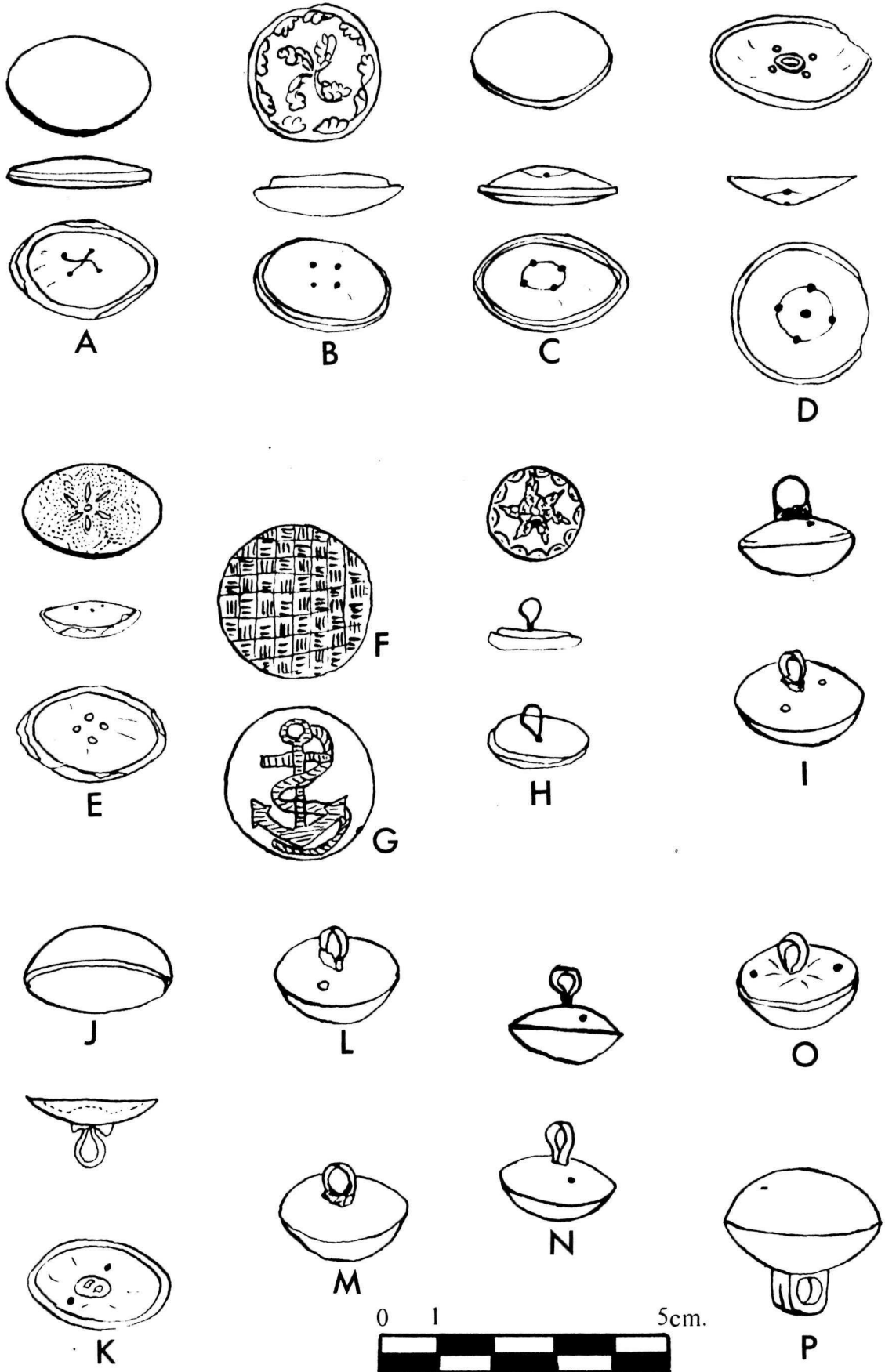

Figure 142. Buttons. Button types: (a) G16, (b) H17,
(c) I18, (d) I19, (e) I20, (f) I21, (g) I22, (h) I23,
(i) I24, (j) I25, (k) J26, (l) J27, (m) J28.

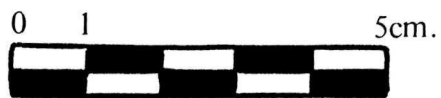
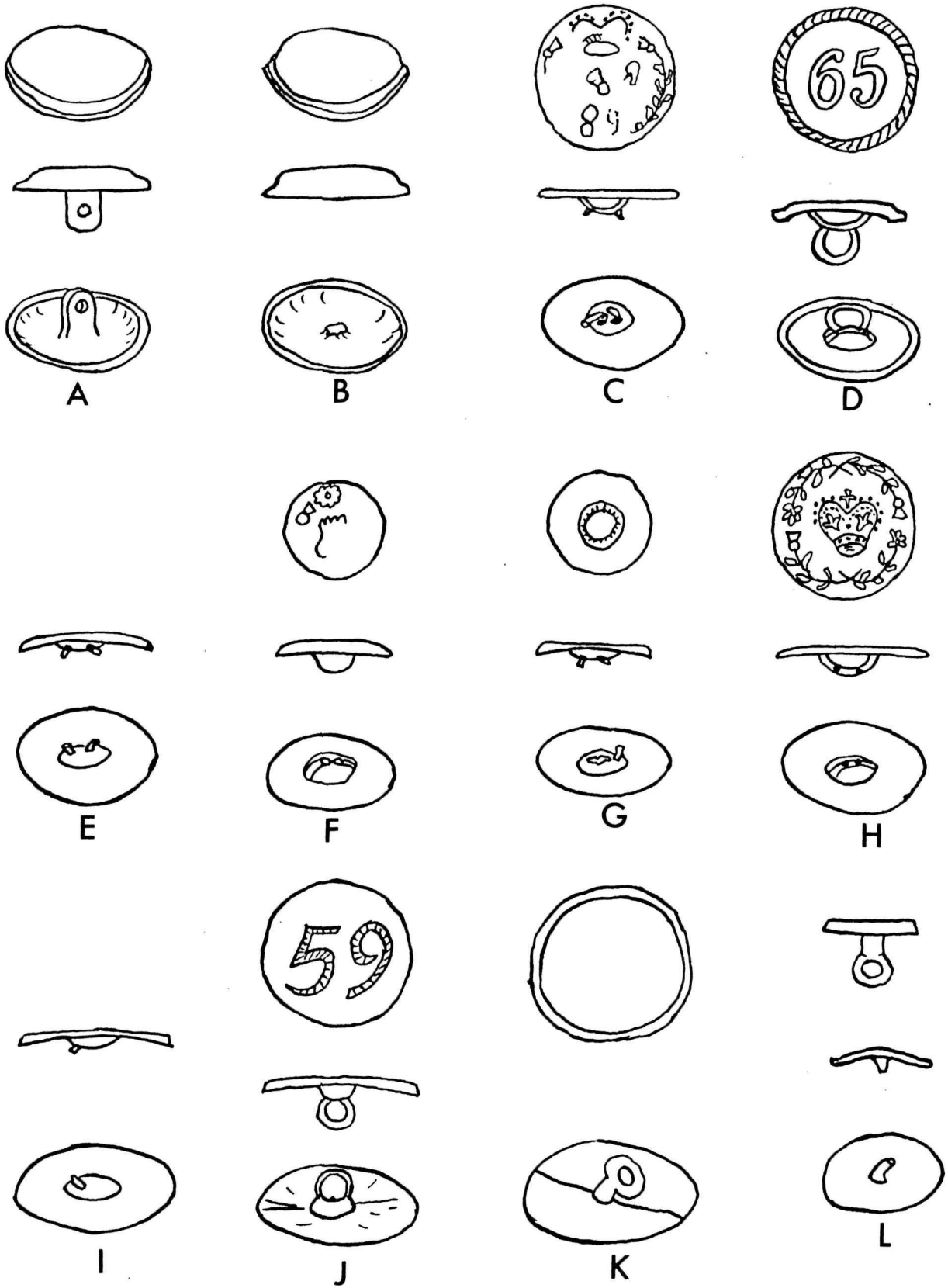
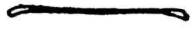
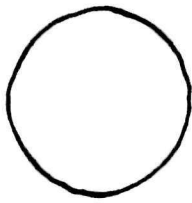
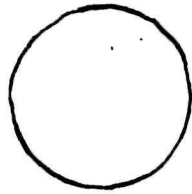

Figure 143. Buttons. Button types: (a) K29,
(b) K30, (c) L31, (d) M32.



A



B

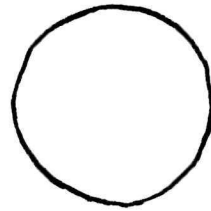

C

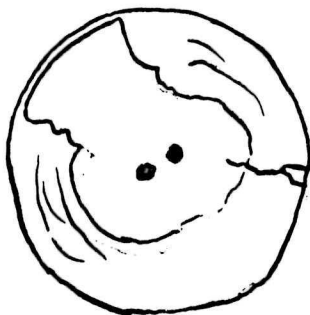
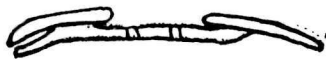
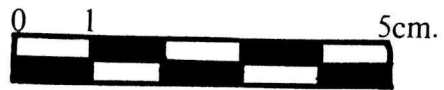
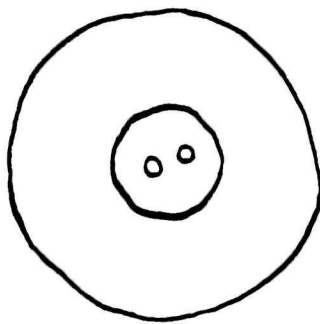

D

Figure 144. Coins and copper artifacts. (a-f) French coins, (g) cockade holder, (h) copper plate, (i) copper strap, (j) copper hook-like object. Scale in cm.

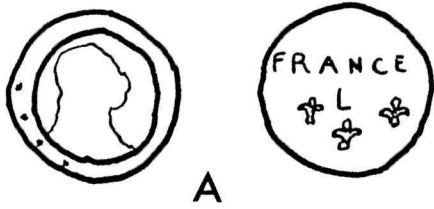

A

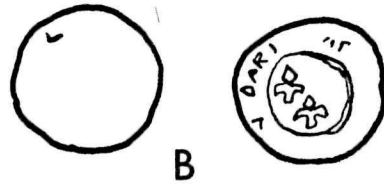

B



C



D

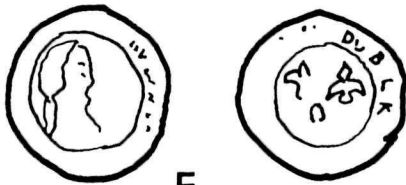

E



F

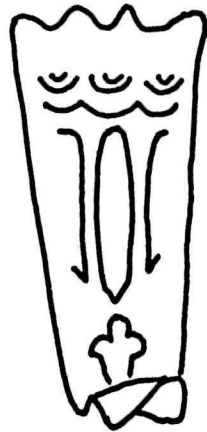

G

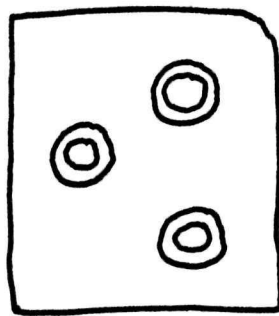

H

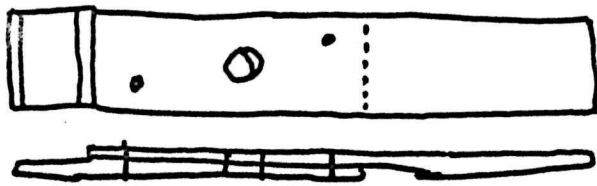

I



J

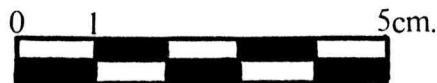
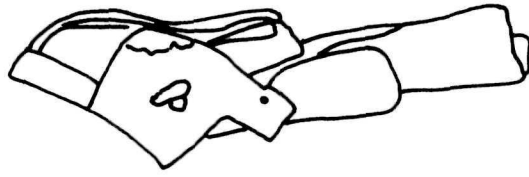
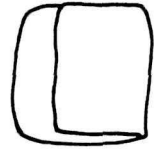

Figure 145. Brass or copper artifacts. (a) rivet
sheets of copper, (b) folder copper strip, (c) copper
strip, (d) cut copper plate, (e) large plate. Scale
in cm.



A



B

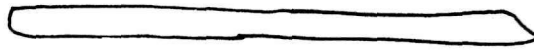

C



CM.

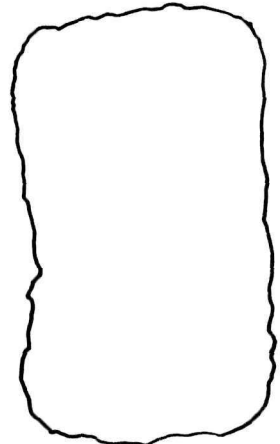

D

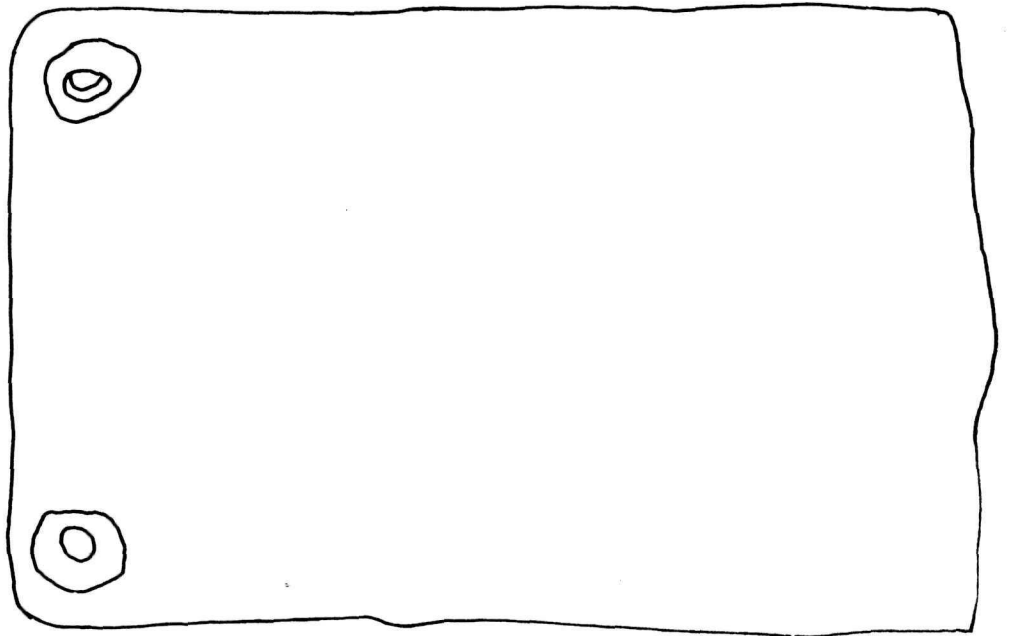

E

Figure 146. Buckles. (a,b) waist belt buckles,
(c-i) shoe buckles. Scale in cm.

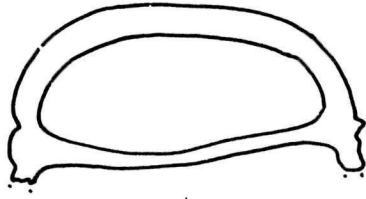

A

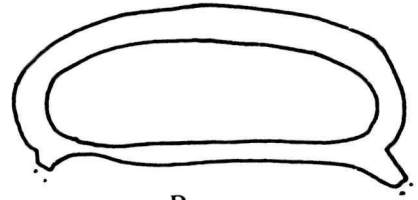

B

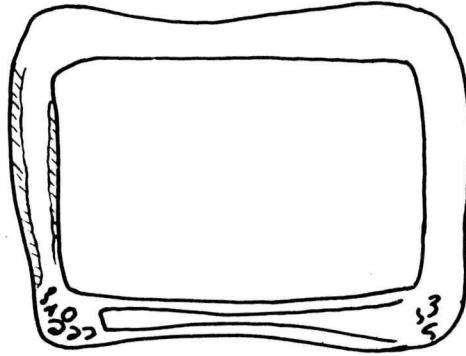

C

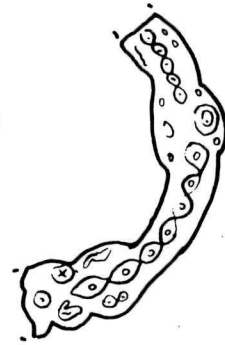

D



E

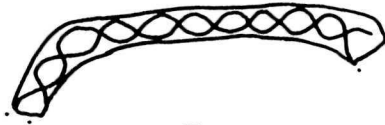

F



G

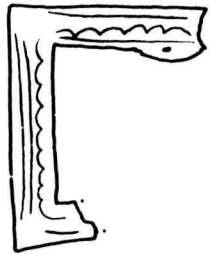

H

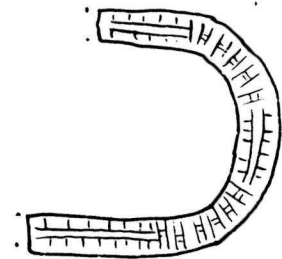

I



Figure 147. Buckles. (a-m) shoe buckle parts.

Scale in cm.

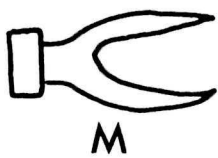
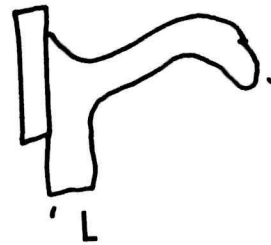
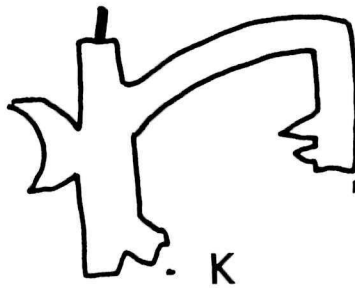
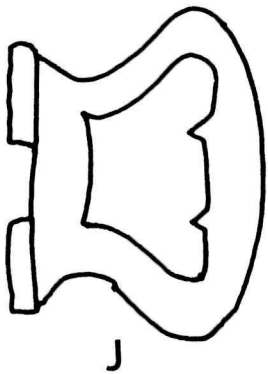
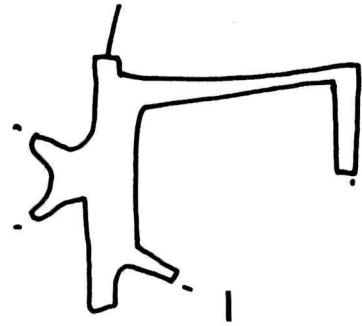
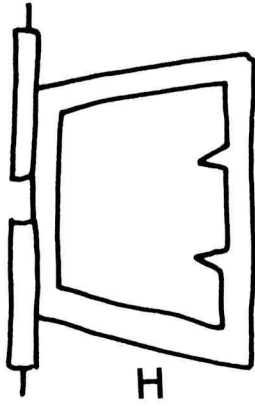
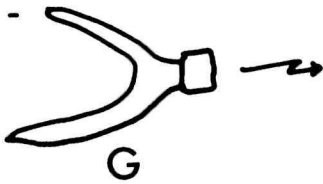
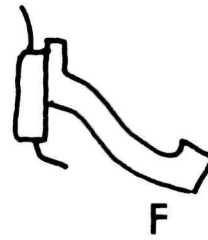
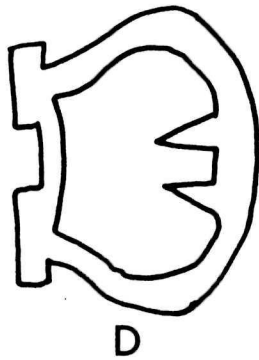
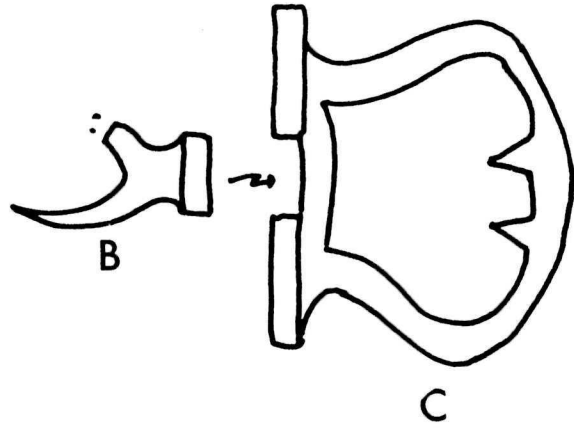
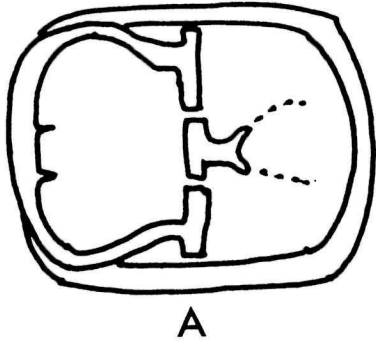
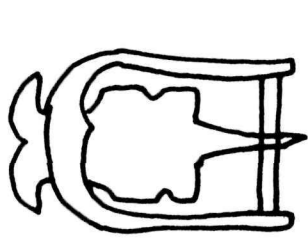

Figure 148. Buckles. (a-f) breeches knee band buckles, (g-m) miscellaneous buckles. Scale in cm.



A



B

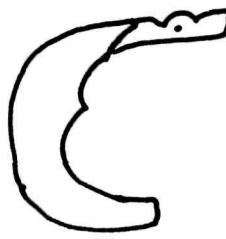

C

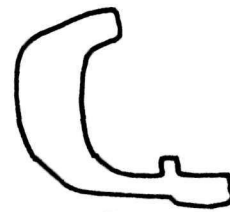

D

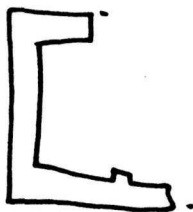

E

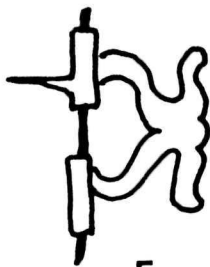

F

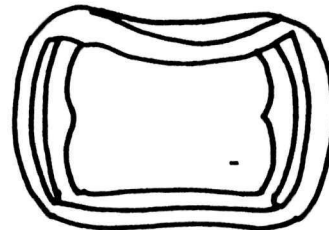

G

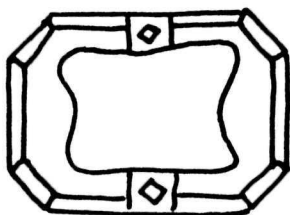

H

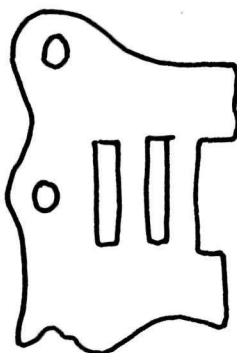

I

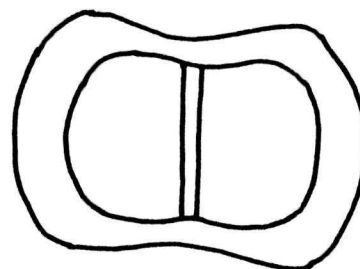

J

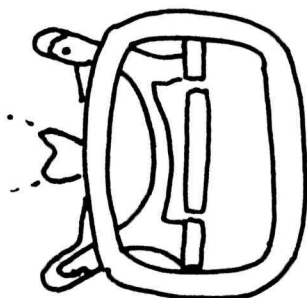

K

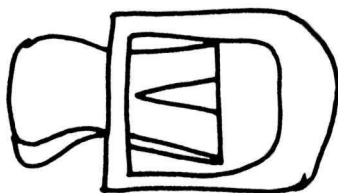

L

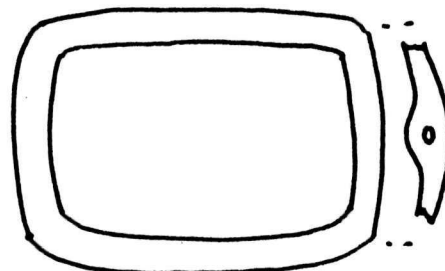

M

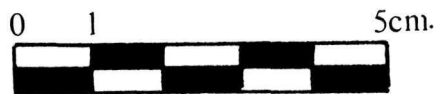
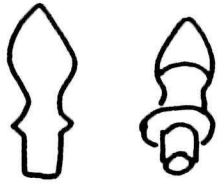
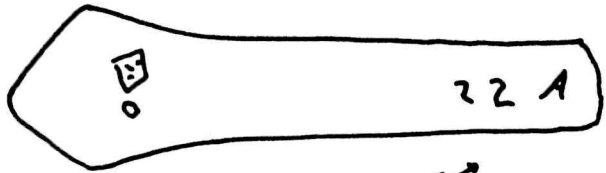

Figure 149. Miscellaneous artifacts. (a) finial,
(b) pewter object, (c,d) jewsharps, (e) string,
(f) shoe fragments. Scale in cm.



A



B

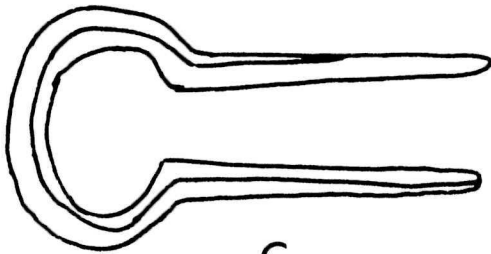

C

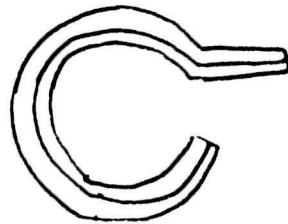

D



E

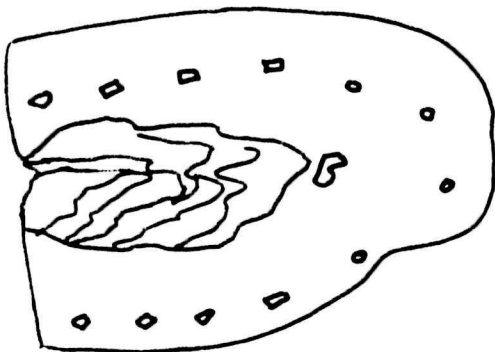

F

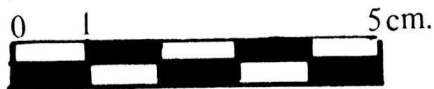
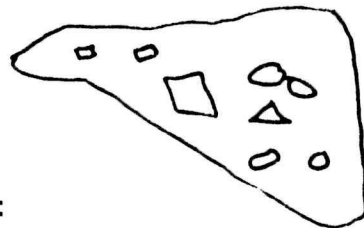
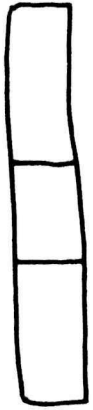
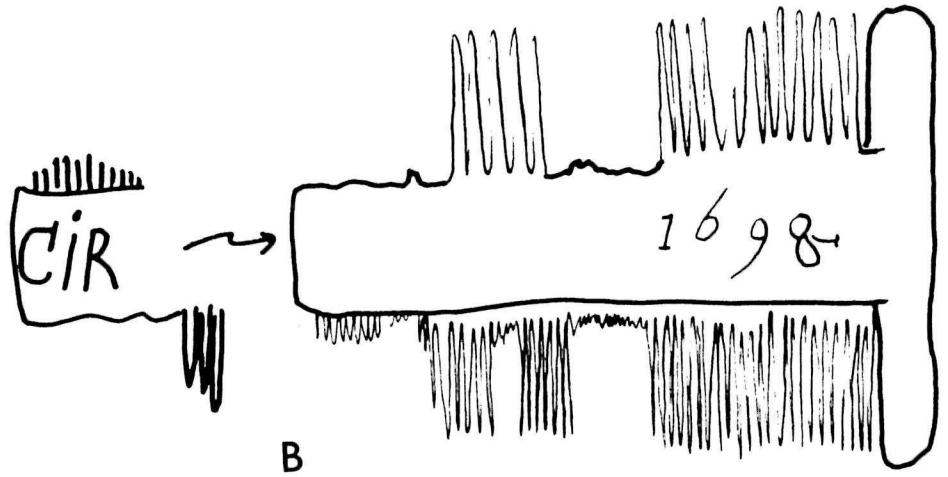

Figure 150. Bone objects. (a-c) combs, (d) finial,
(e) whistle made of bird bone, (f) drilled bone
object, (g) celluloid box. Scale in cm.



A



B



C



D

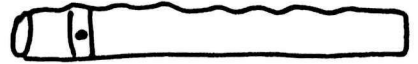

E

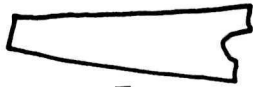

F



G

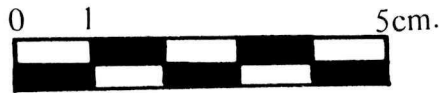

Figure 151. Fishing equipment. (a) gaff, (b-i) fish hooks, (j) fish hook straightened as lobster spear. Scale in cm.

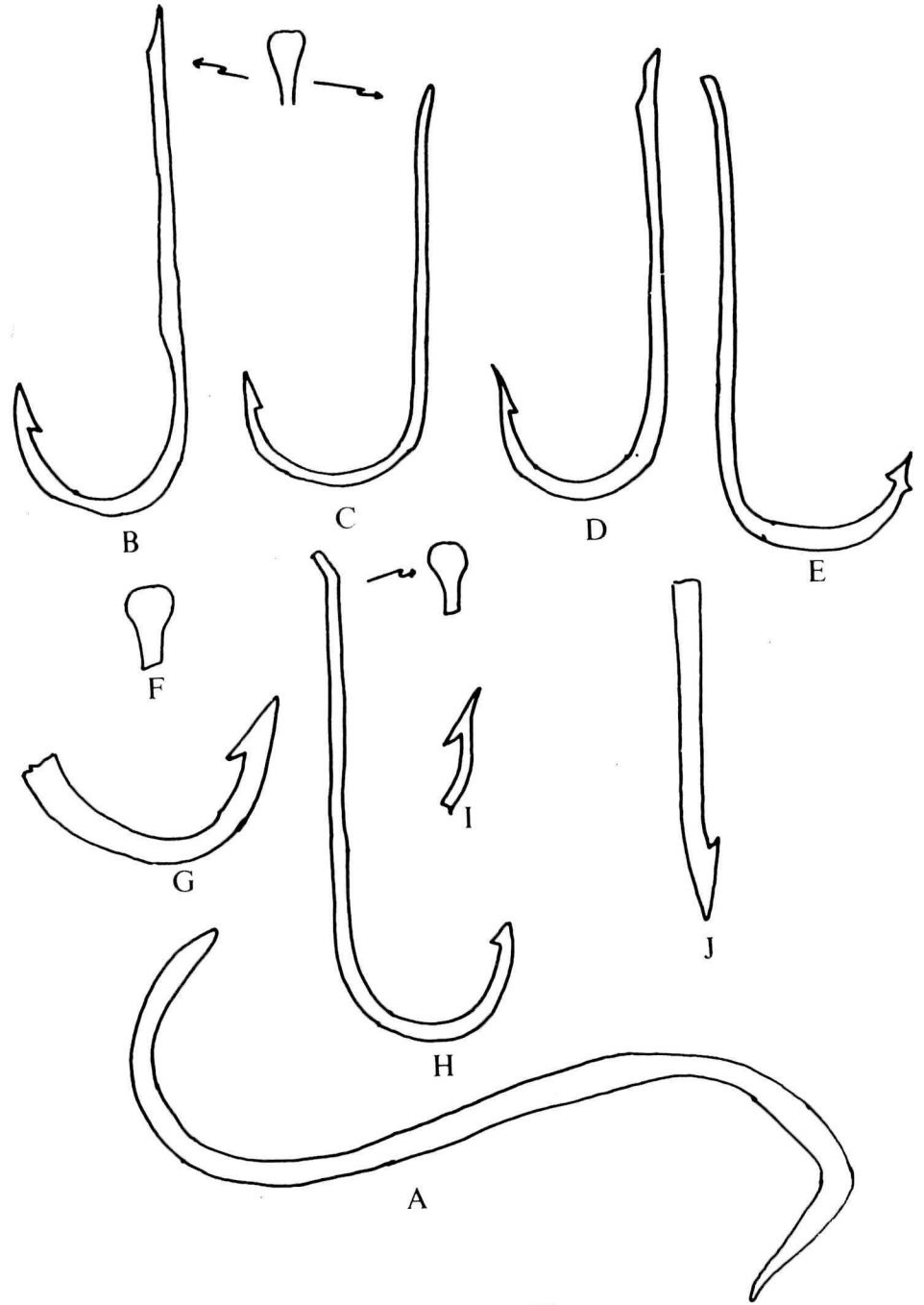
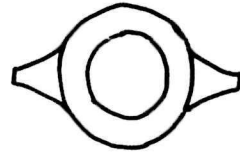
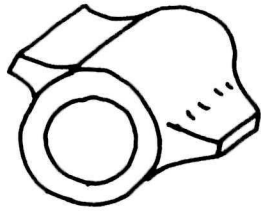

Figure 152. Miscellaneous artifacts. (a) flanged bearing, (b,c) chain links, (d) ice creeper, (e) hook. Scale in cm.



A



B

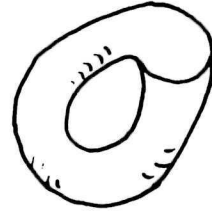

C

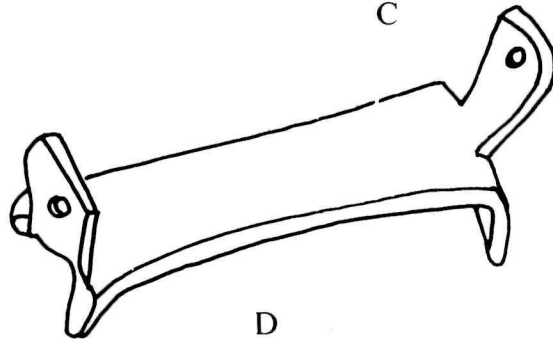

D

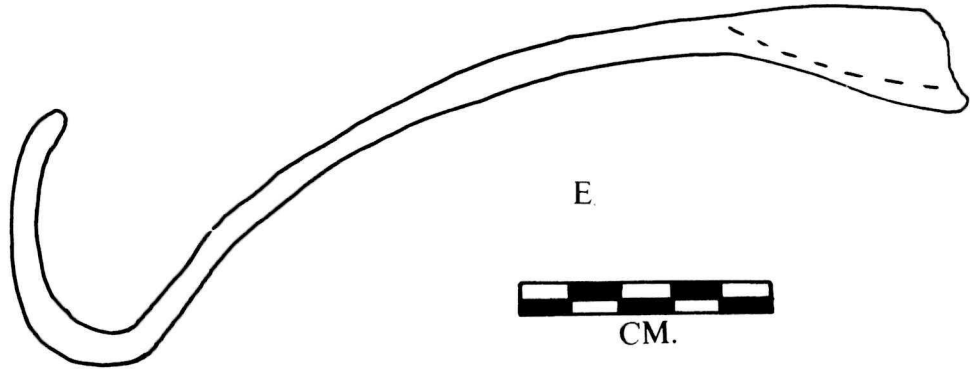

E



Figure 153. Hooks. Scale in cm.

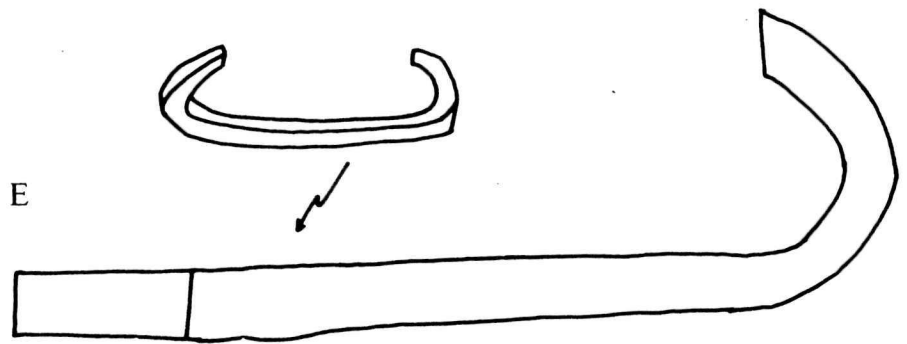
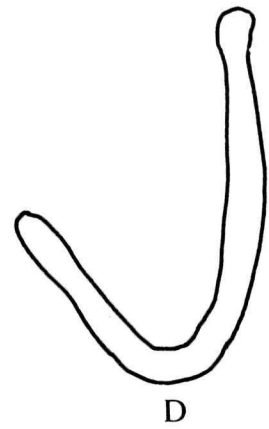
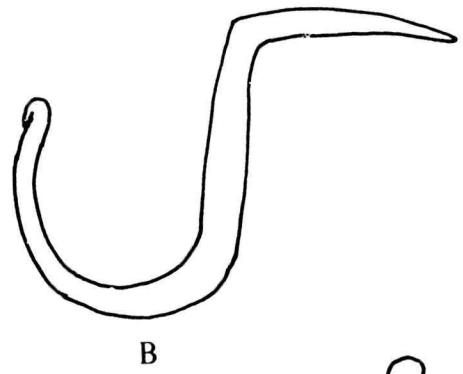
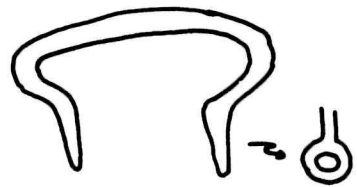
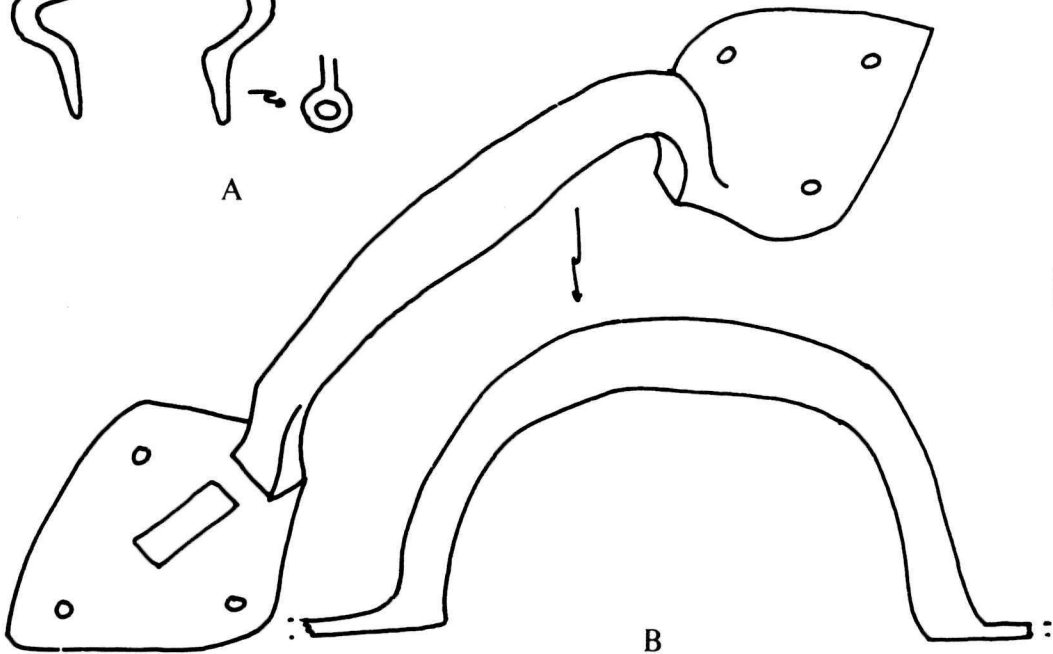

Figure 154. Handles. (a) small pull, (b-e) large handles, (c) twisted iron handle, (d) plain strap handle? Scale in cm.



A



B

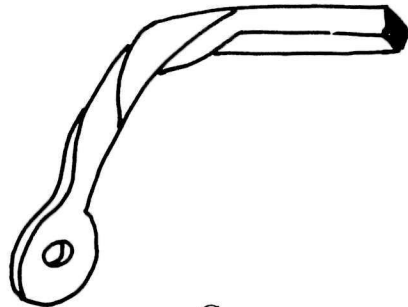

C

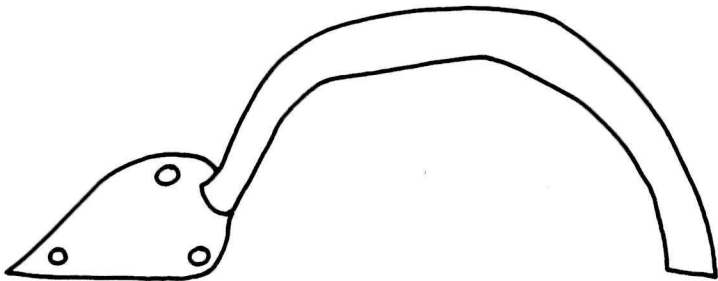

E



D

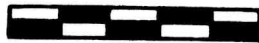

CM.

Figure 155. Iron artifacts. (a) horseshoe blank, (b) horseshoe fragment, (c) ox shoe, (d) bit, (e) thimble for rope eye. Scale in cm.

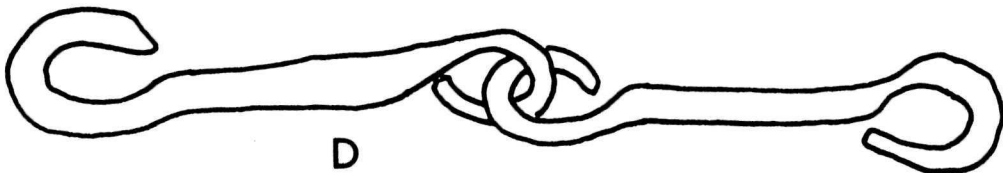
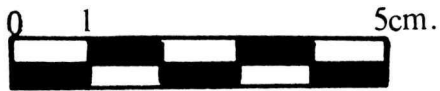
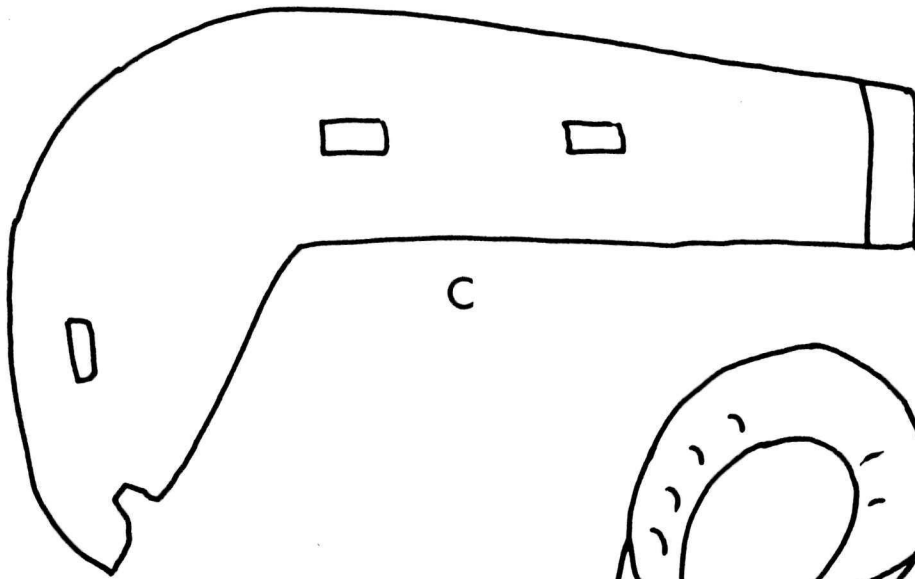
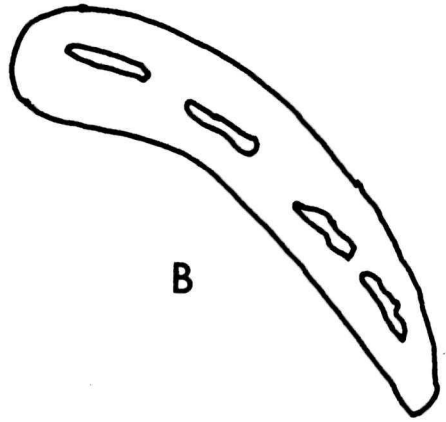
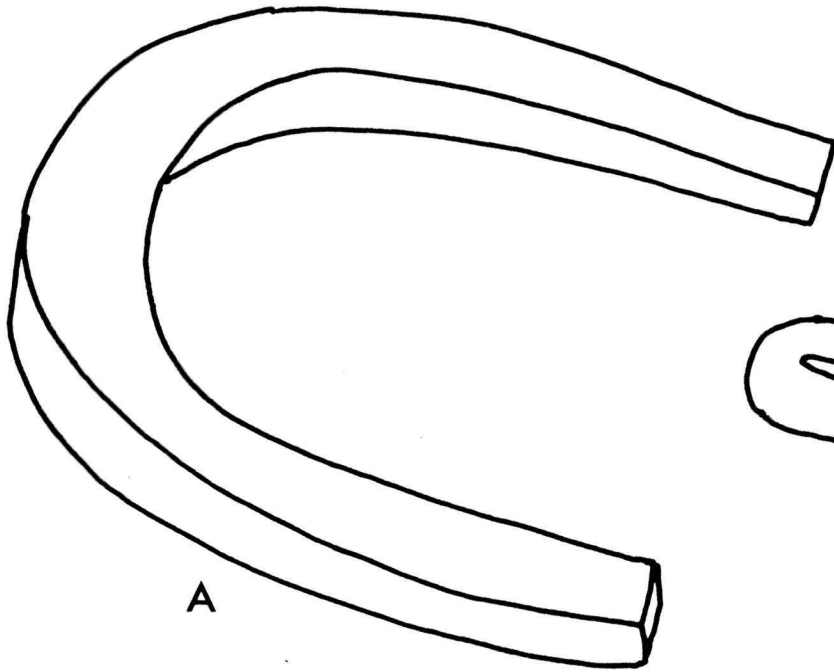
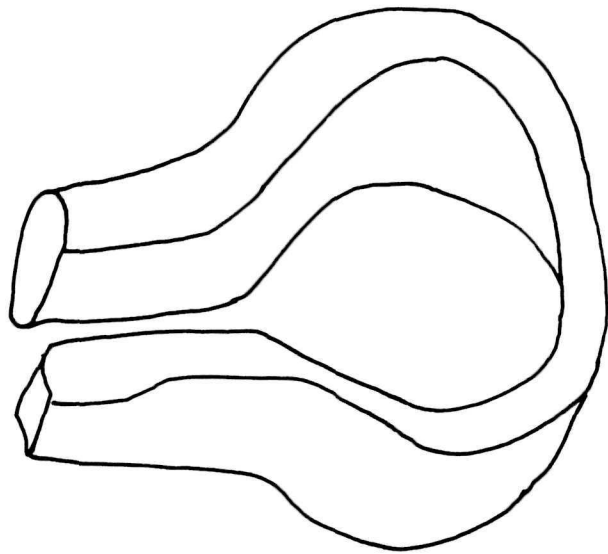

Figure 156. Iron artifacts. (a) clevis? (b-g)
miscellaneous artifacts. Scale in cm.



A



B

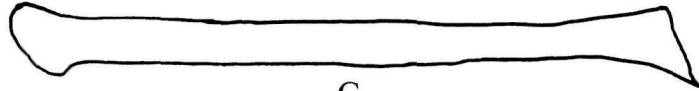

C



E

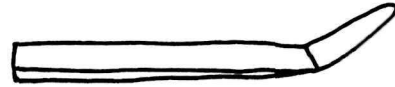

F

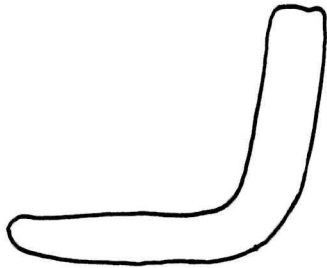

D

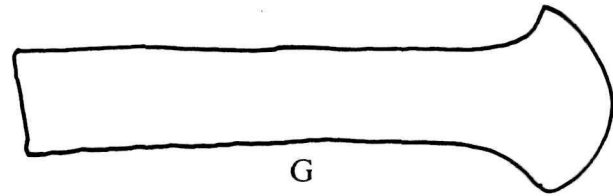

G



CM.

Figure 157. Iron artifacts. (a-f) miscellaneous,
(g) unidentified object, not to scale. Scale in
cm.

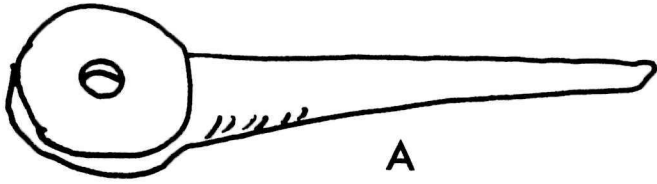

A

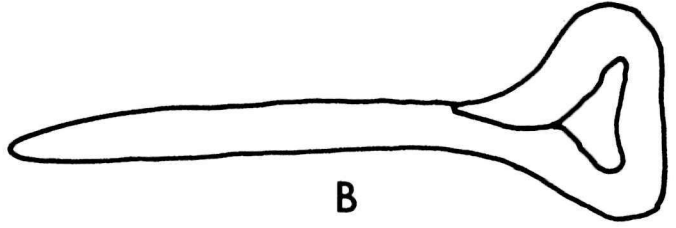

B

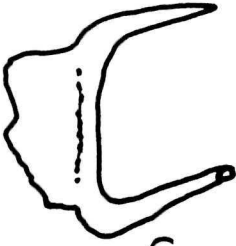

C

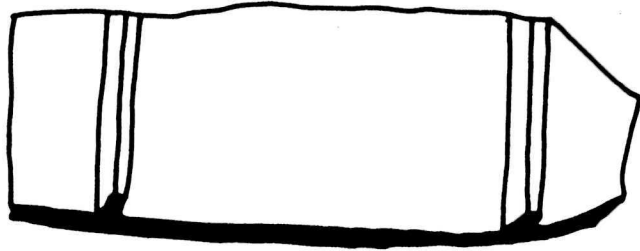

E

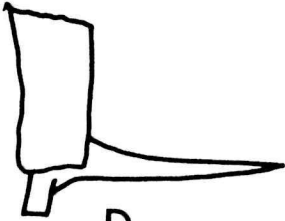

D

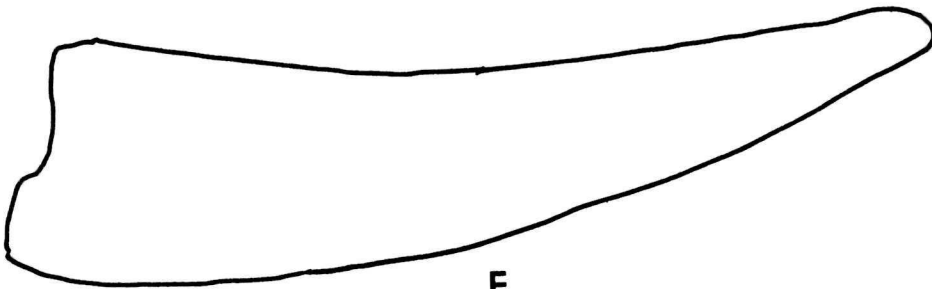

F

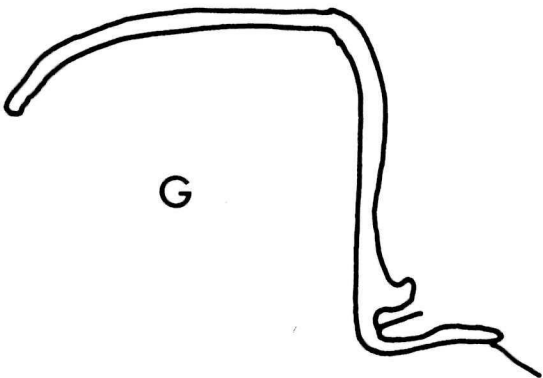
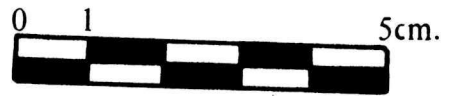

G

Figure 158. Lock plates. (a) plate fragment with bolt held by two keepers, (b) side view of large keeper attached to fragment of plate, (c) side view and (d) top view of ward assembly from stock lock, (e) interior view of stock lock plate with bolt keeper, spring and tumbler in situ, (f) interior view of lock plate with three perforations at top, shelf at bottom and horseshoe-shaped attachment. Scale in cm.

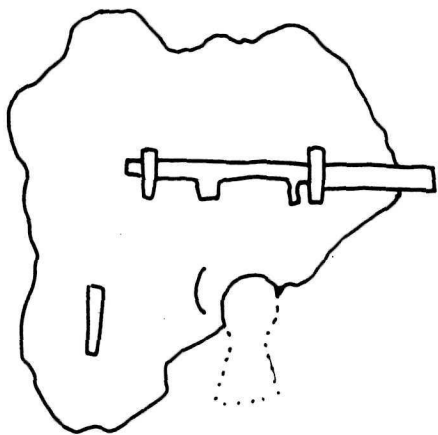

A



B

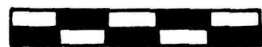

CM.

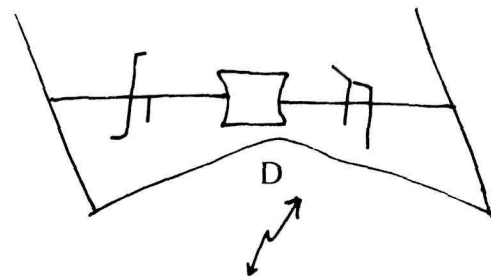

D

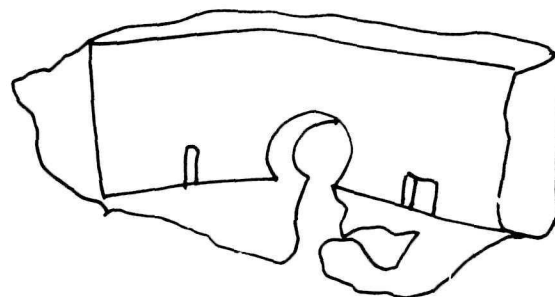

C

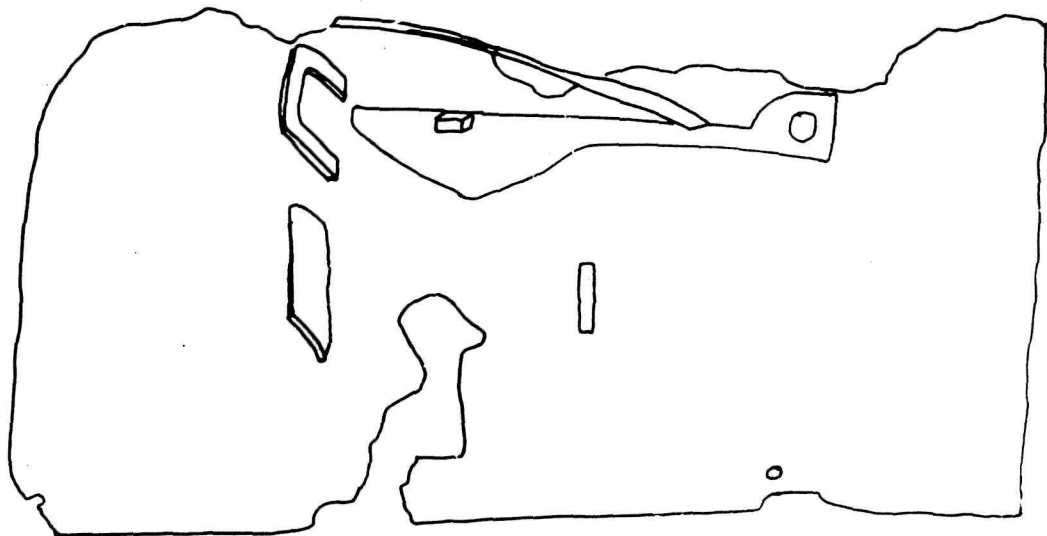

E

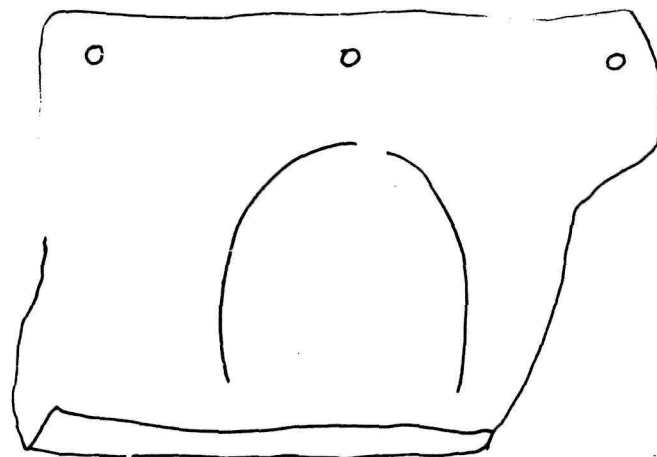

F

Figure 159. Lock parts. (a) bolt from stock lock, (b) bolt with spring, (c) tumbler from stock lock, (d) possible lock part, (e) top view and (f) side view of thin sheet with right angled projections, (g) side and (h) top views of possible lock part, (i) spring, (j,k) small bolt fragments, (l) bi-pointed pivot, (m) large keeper. Scale in cm.

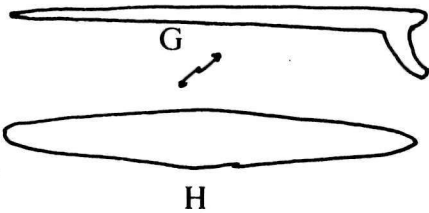
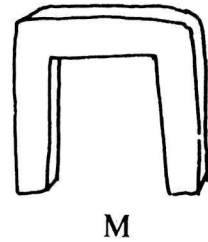
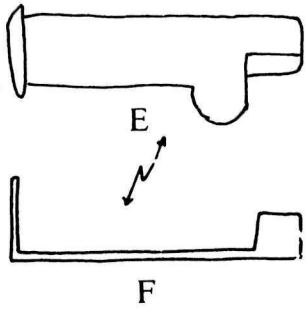
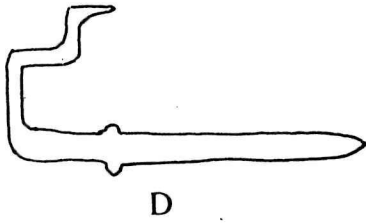
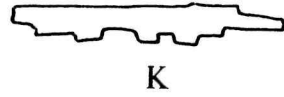
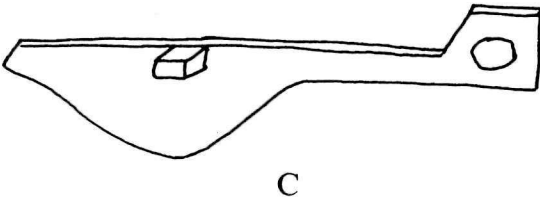
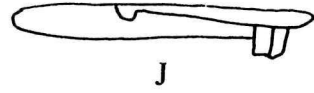
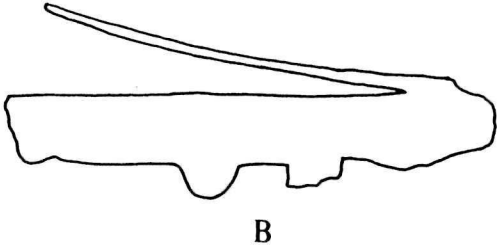
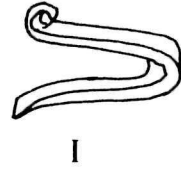
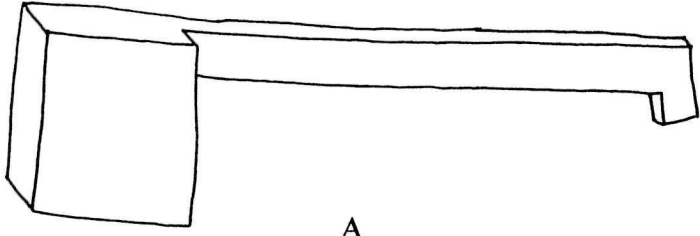
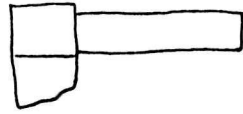

Figure 160. Keys and key hole escutcheons. (a,b)
escutcheons, (c-e) keys. Scale in cm.



C



A

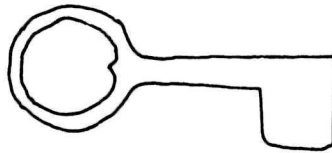

D

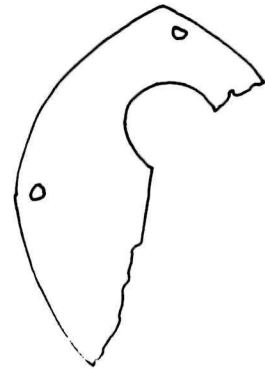

B

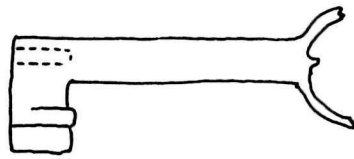

E



CM.

Figure 161. Padlocks. (a) key hole cover, (b) shackle, (c) face plate fragment, (d) nearly complete padlock, (e) exterior and (f) interior views of probable padlock fragment. Scale in cm.

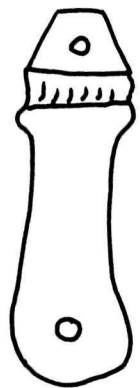

A

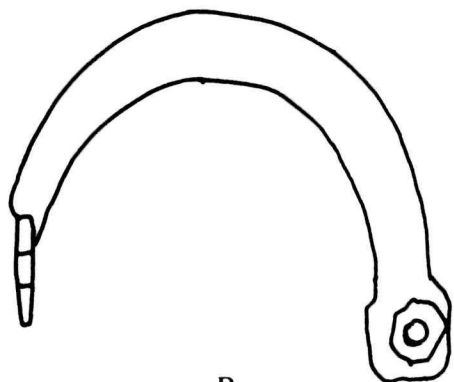

B

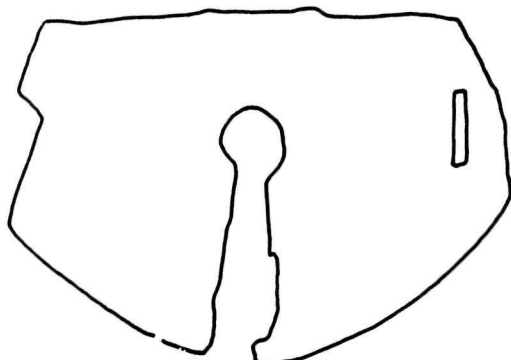

C

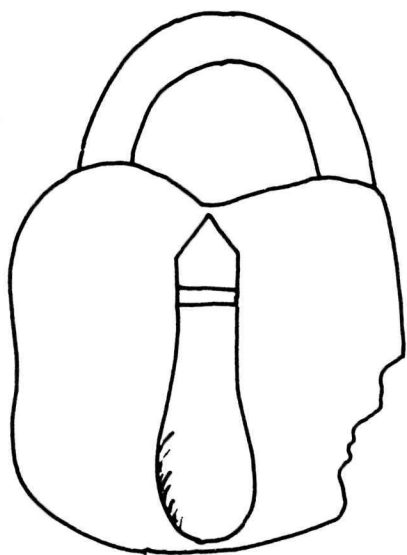

D

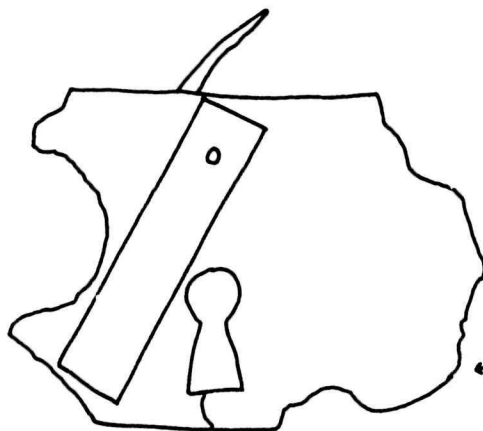

E

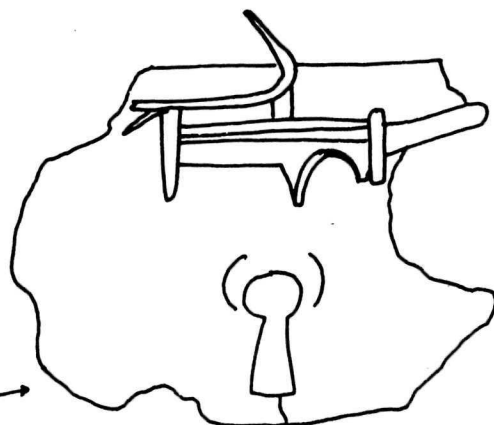

F

Figure 162. Latches. (a-d) latch handles, (e) hook, (f,g) thumb latches. Scale in cm.

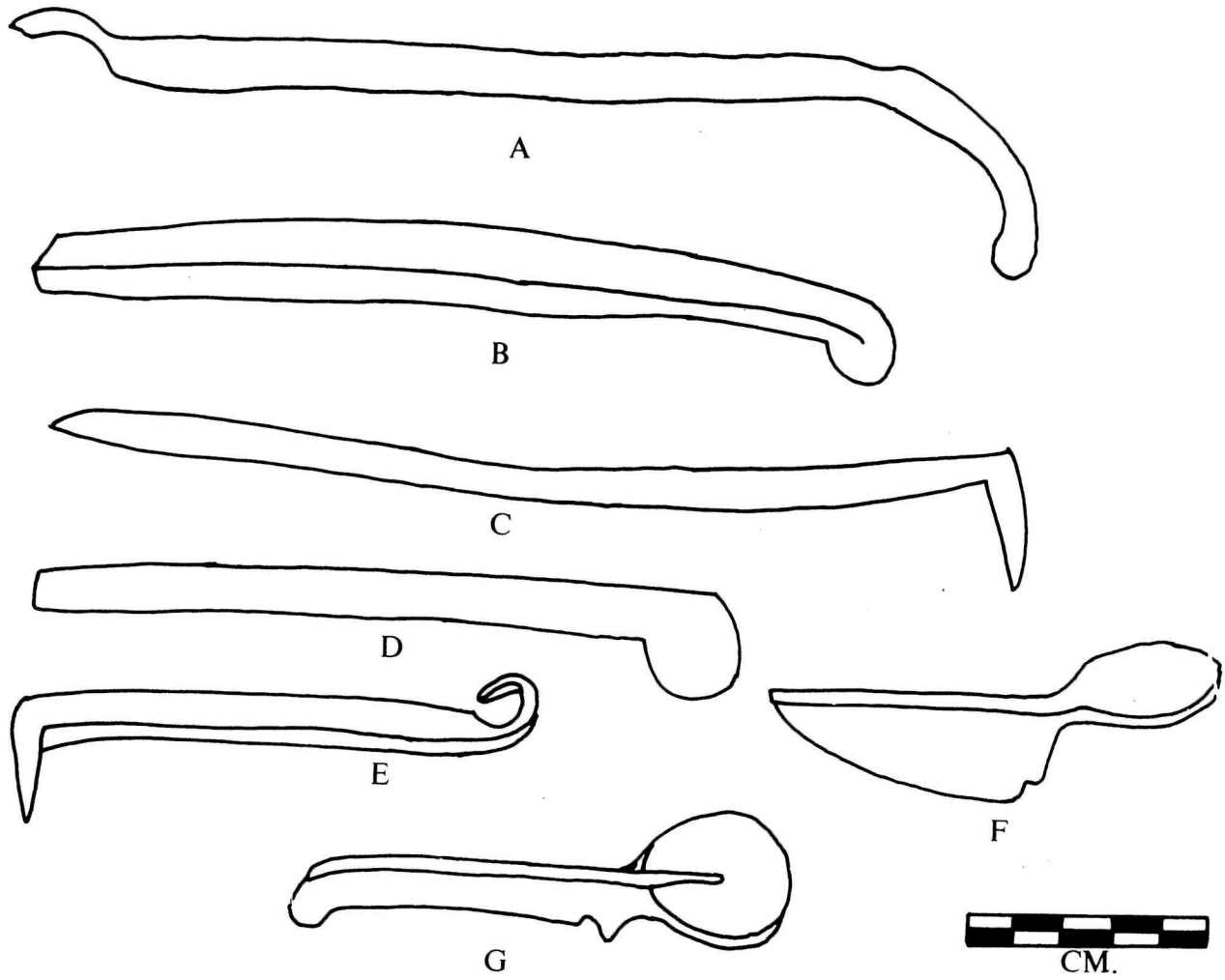

Figure 163. Hinges. (a) tanged pintle, (b) rolled end of strap hinge, (c) tanged gudgeon, (d) fragment of strap hinge, (e) butterfly hinge. Scale in cm.

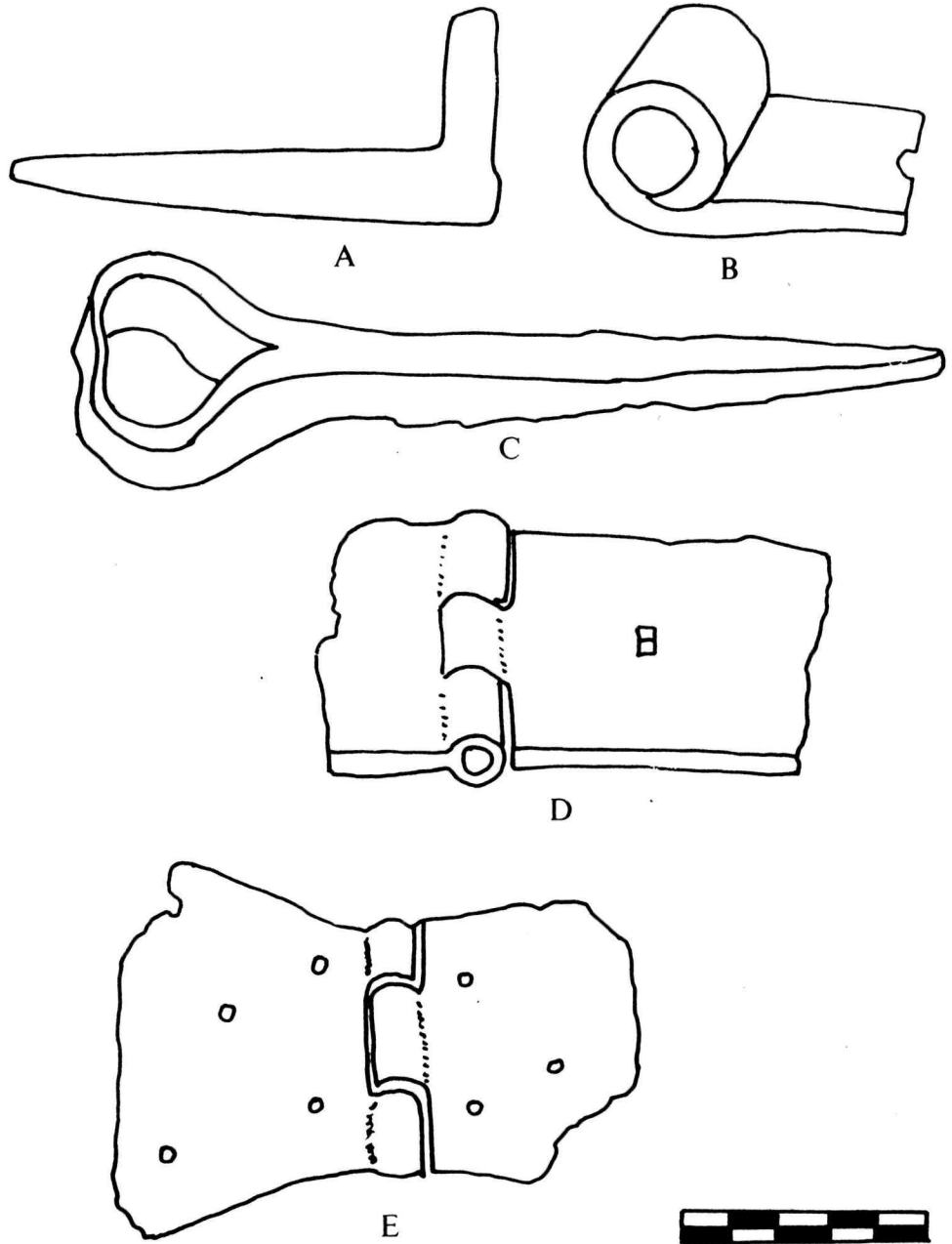
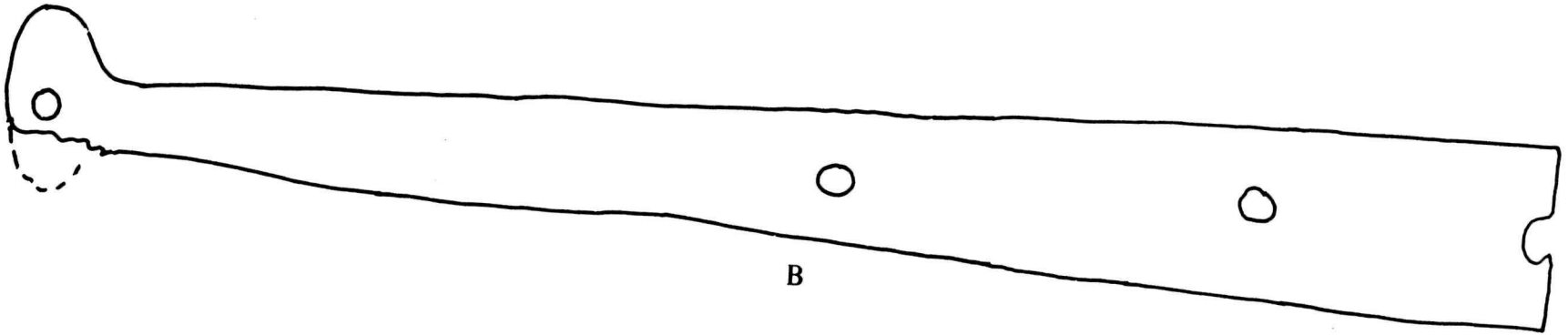

Figure 164. Strap hinges. Scale in cm.



A



B

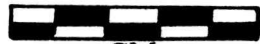

CM.

Figure 165. Hinges. (a) T strap hinge, (b) hinge with loop. Scale in cm.

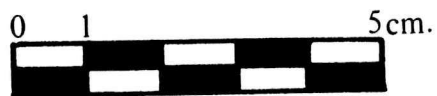
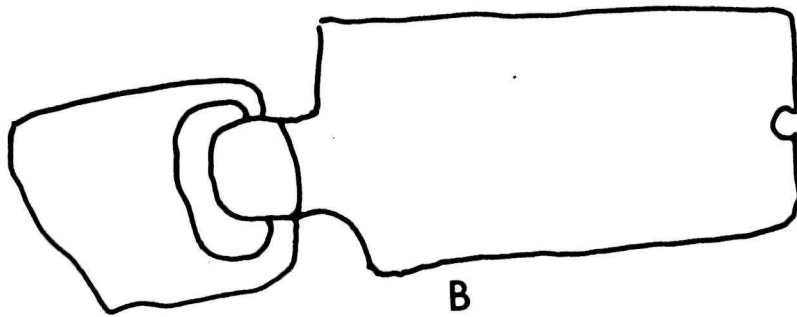
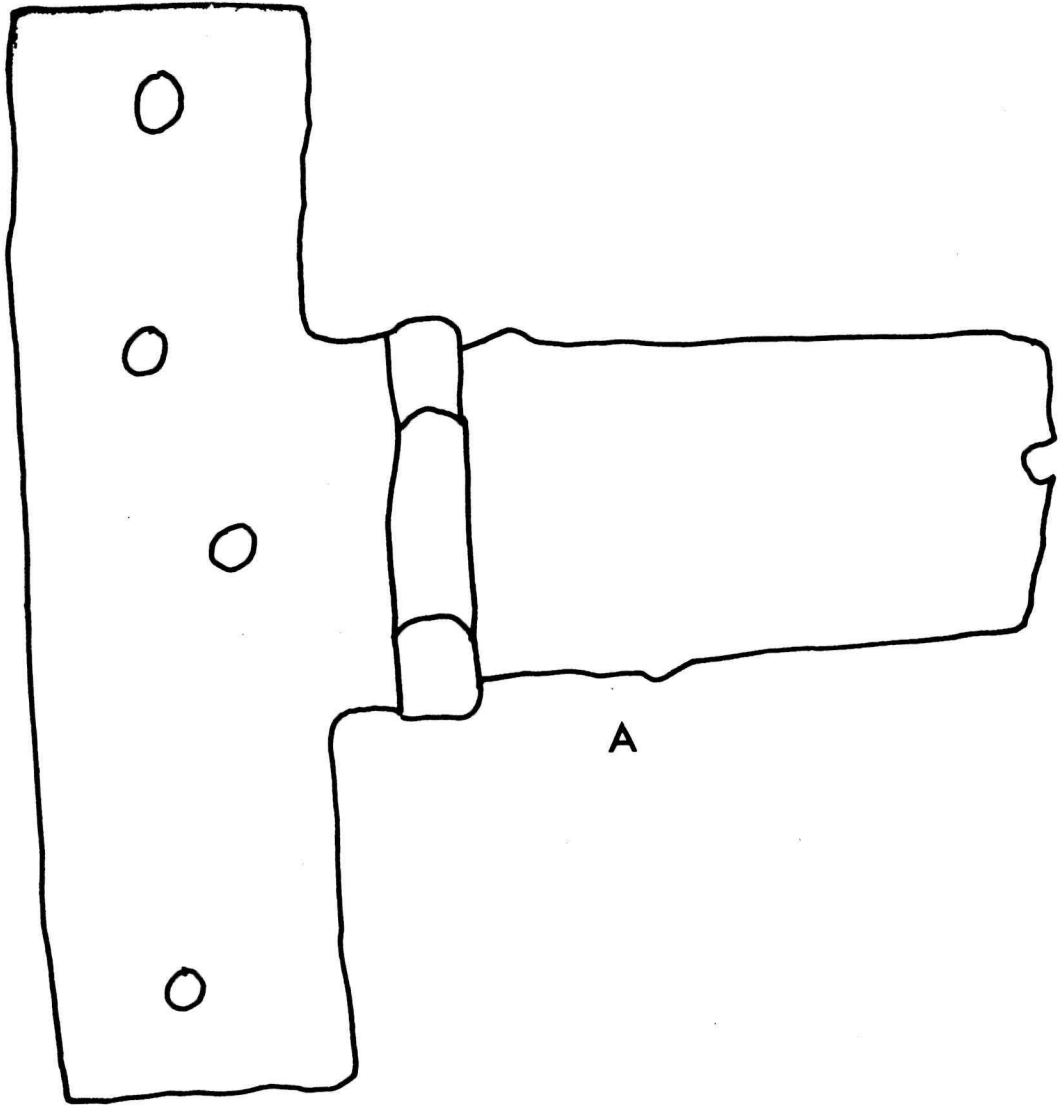

Figure 166. Hinges. (a) part of H hinge, (b) part of H hinge. Scale in cm.

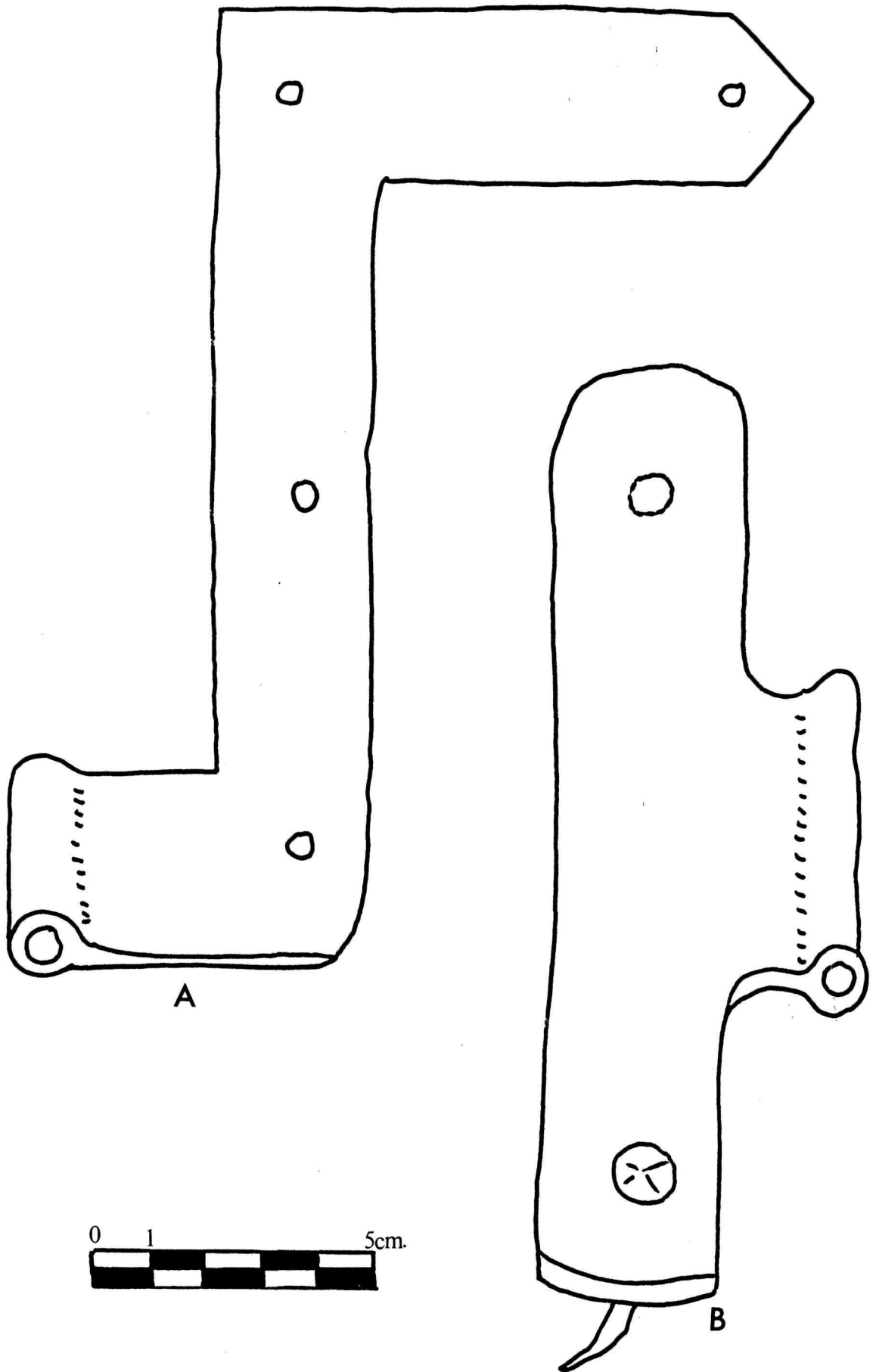

Figure 167. Structural iron. (a) drift pin, (b) twisted fragment of hanger, (c) beam hanger. Scale in cm.

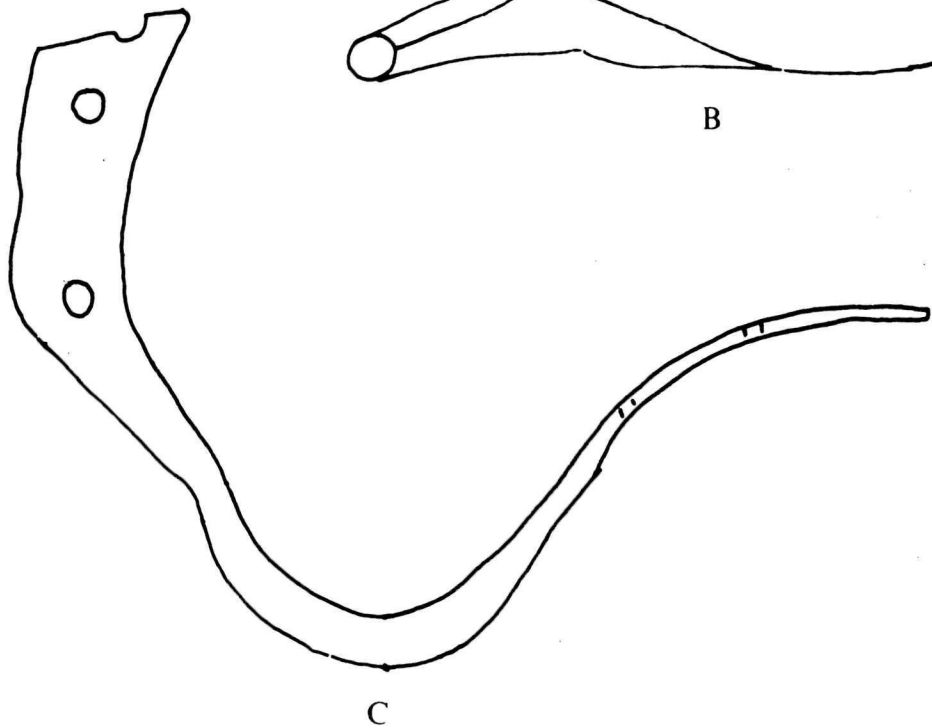
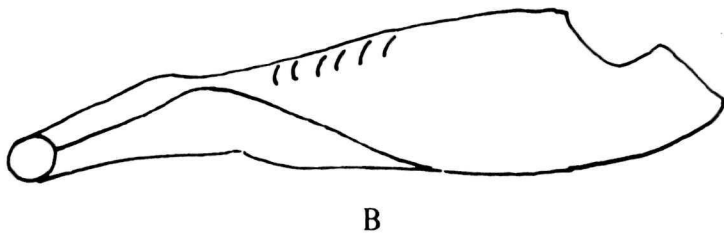
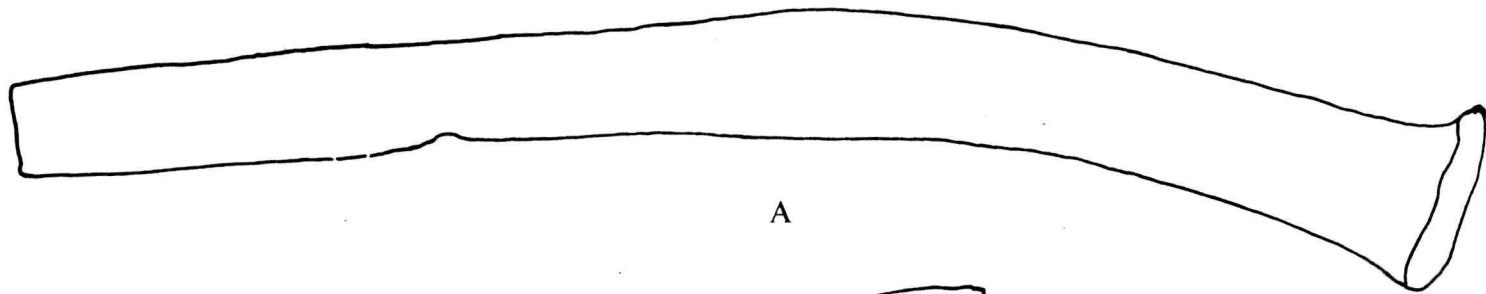

Figure 168. Timber braces. (a) complete, (b) with riveted roove in situ. Scale in cm.

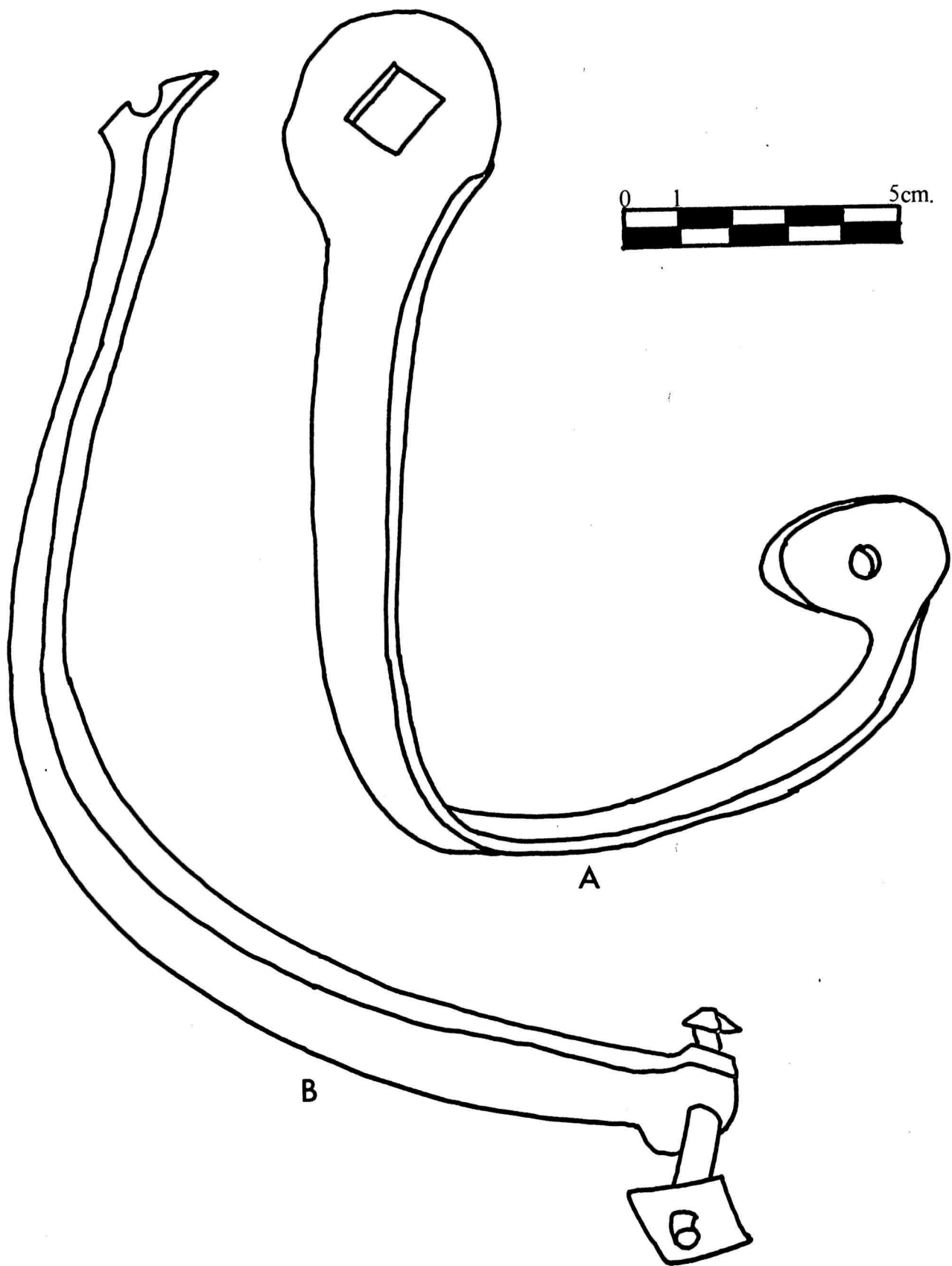

Figure 169. Hangers. (a-c) beam hangers. Scale
in cm.

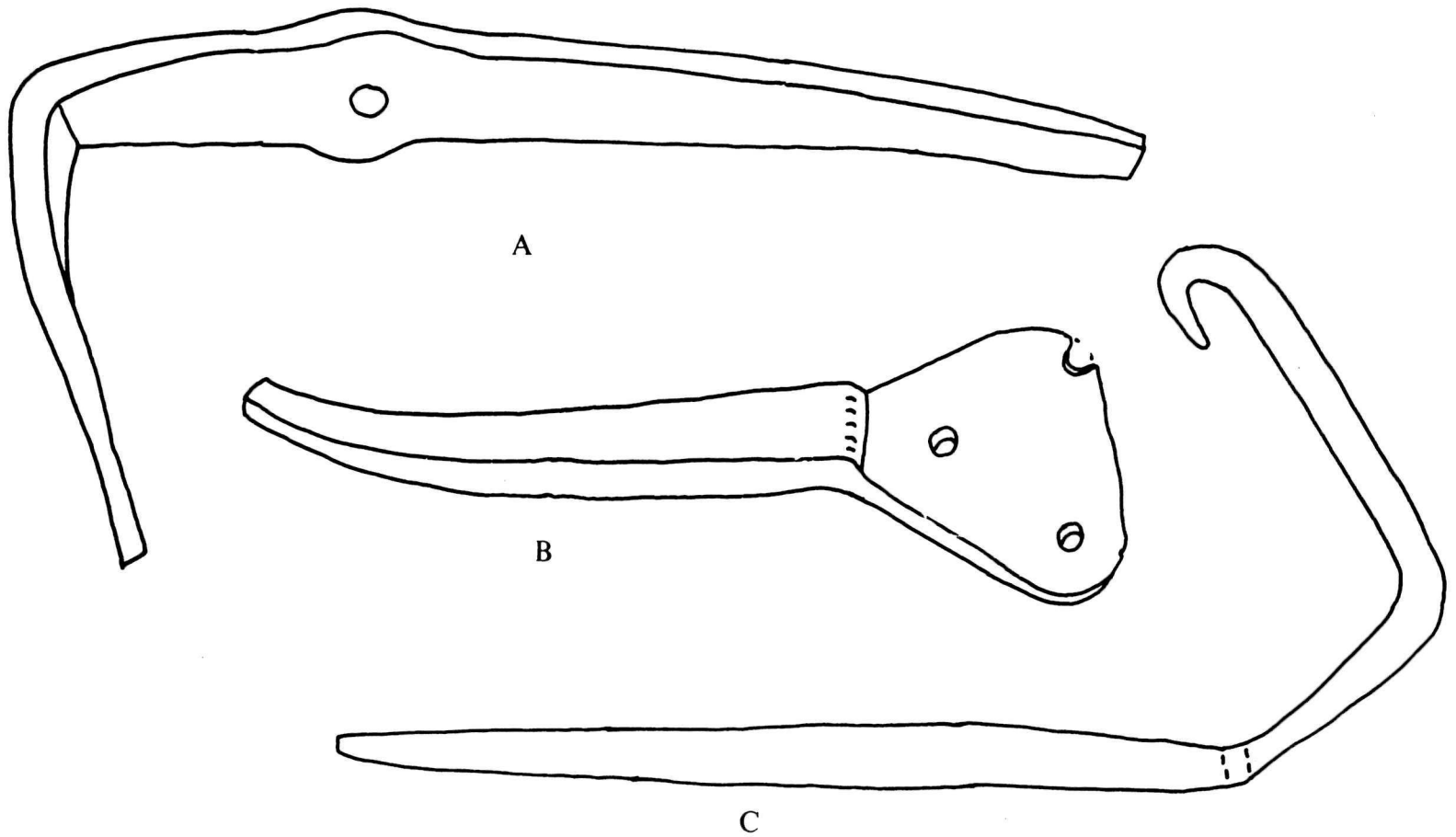
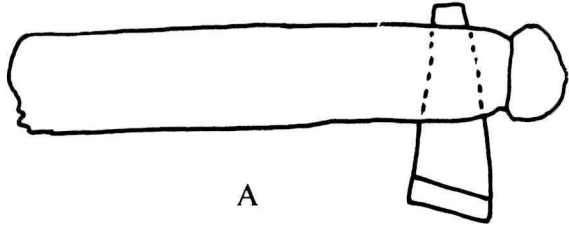

Figure 170. Miscellaneous iron artifacts. (a) slotted rod with cotter key in situ, (b) strap with loop end, (c,d) beam hangers. Scale in cm.



A



B

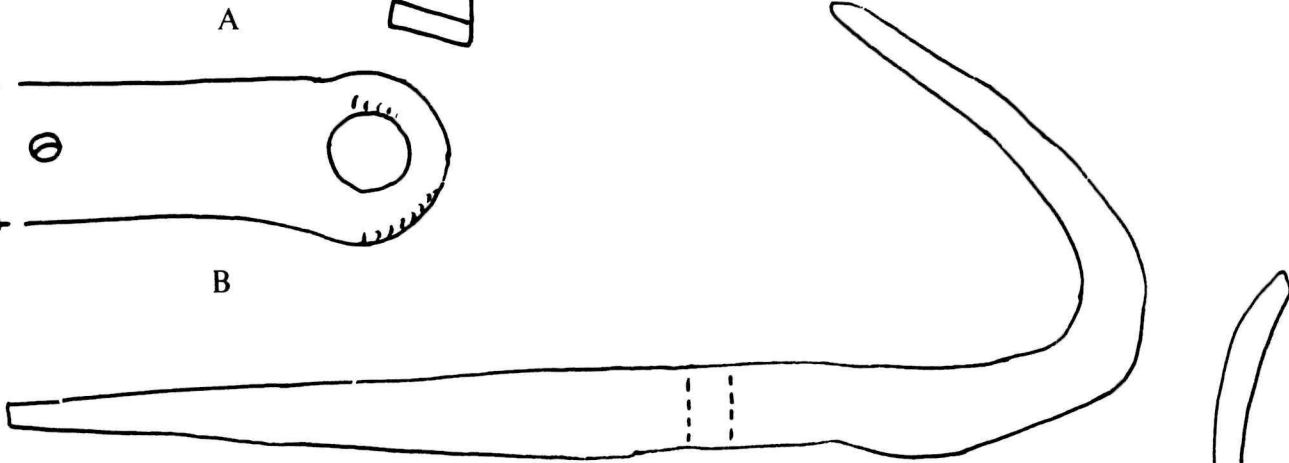

C

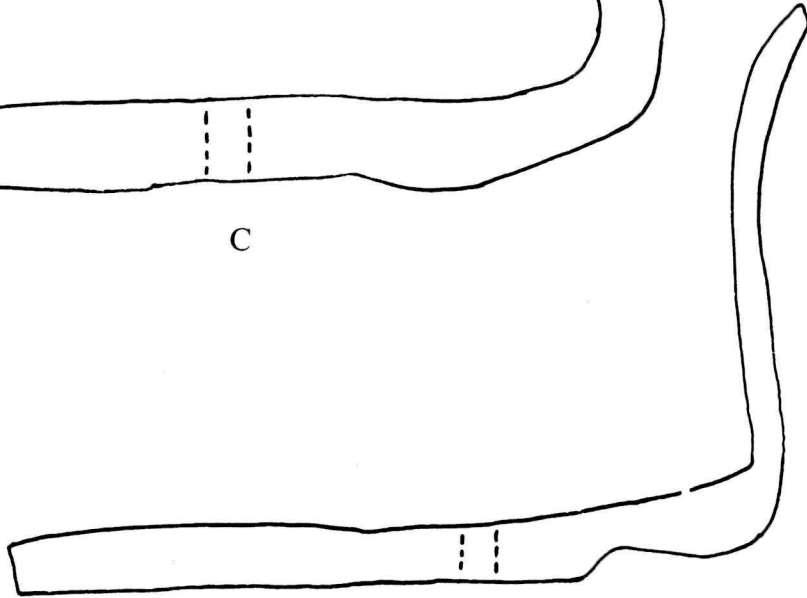
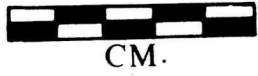

D

Figure 171. Miscellaneous iron artifacts. (a) tanged rod, (b) large bolt fragment? (c) drain clamp, (d) iron rod found in situ in doorway of operation 1, served as temporary hinge?, (e,f) unidentified objects, (g) fastener, (h) spring-like clamp or cotter. Scale in cm.

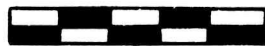

CM.

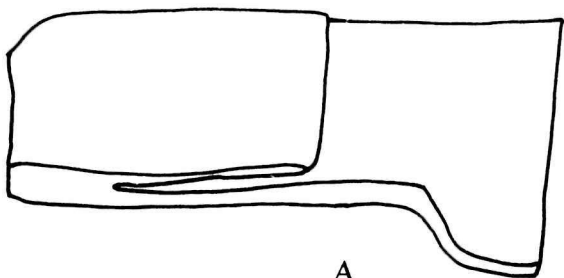

A

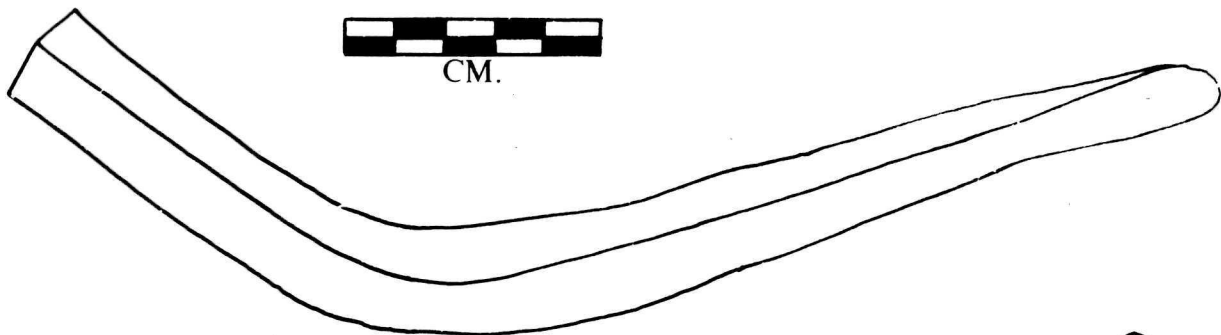

B

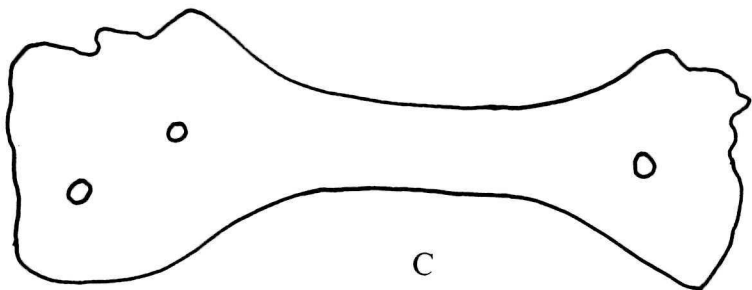

C



D

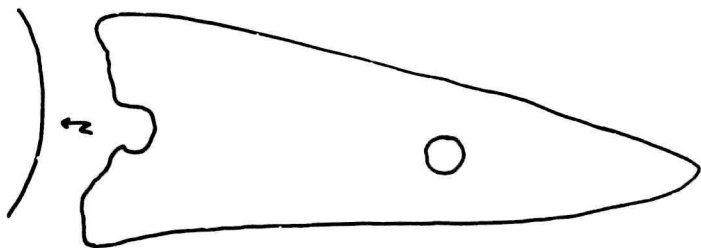

E

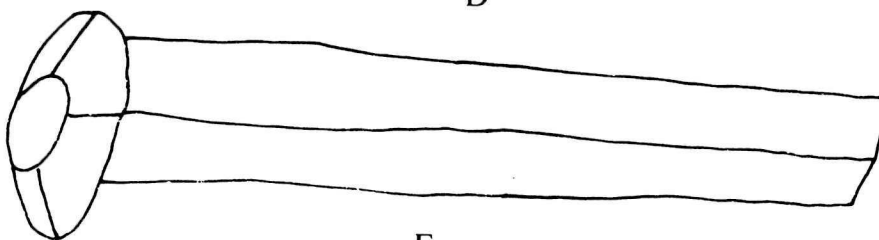

F

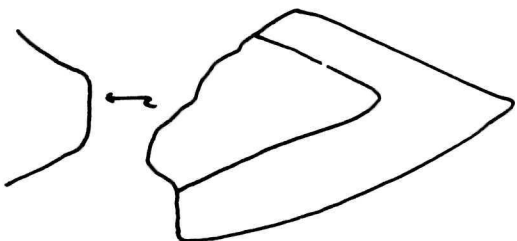

G



H

Figure 172. Rooves and bolts. (a) riveted roove,
(b) bolt, (c) bolt and nut, (d) bolt, nut and washer,
(e) long cotter key bolt. Scale in cm.

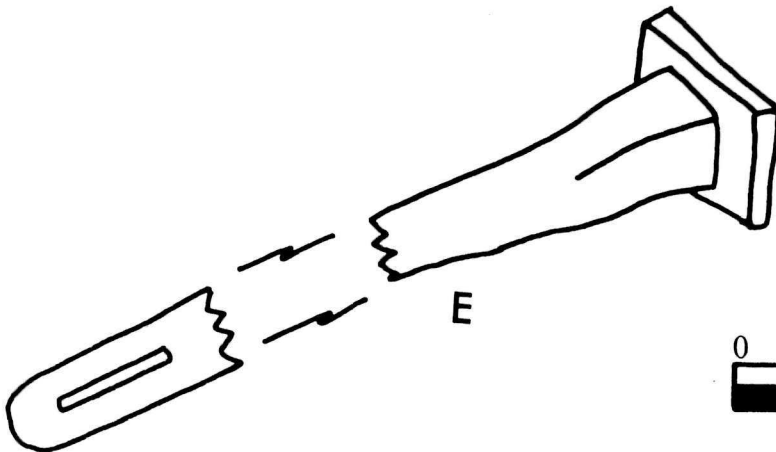
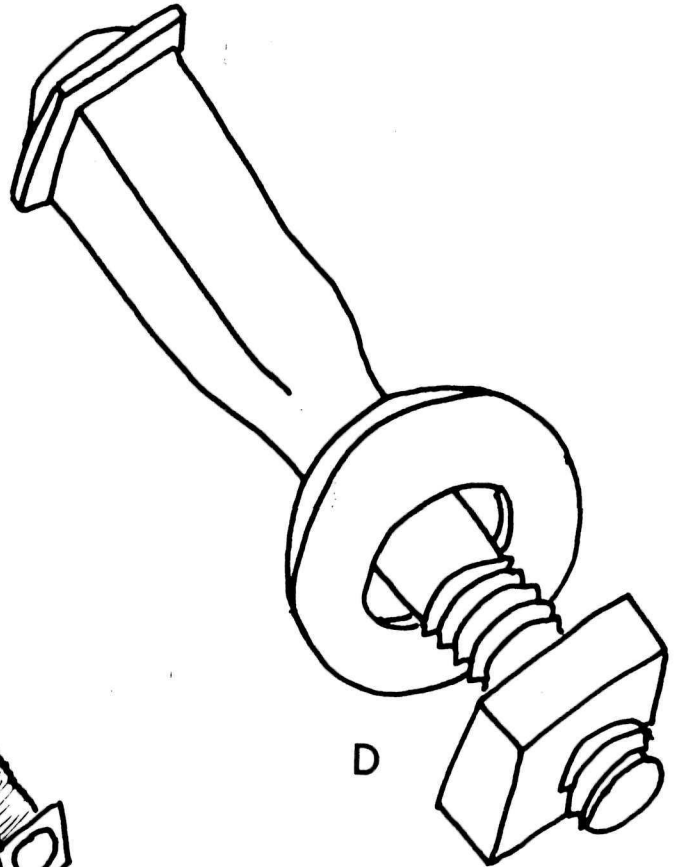
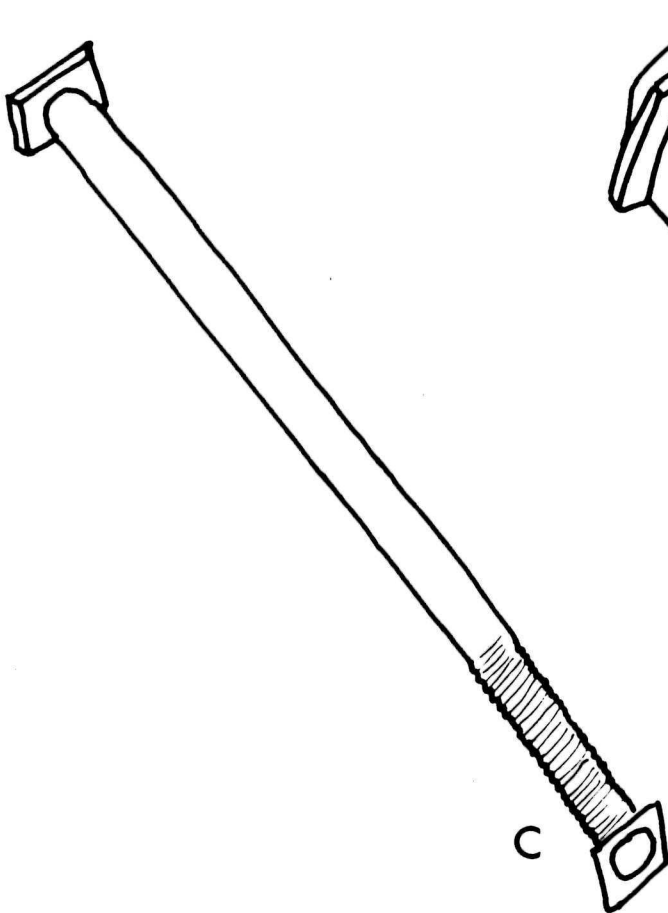
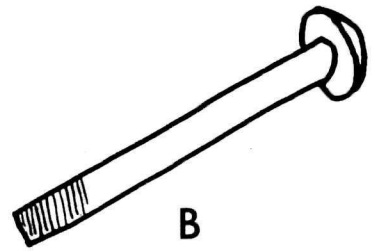
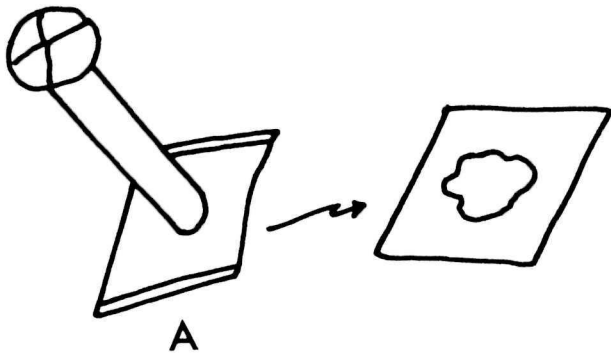

Figure 173. Rings and washers. (a) ring, (b,d) washers, (c) ring, (e) hub band? Scale in cm.

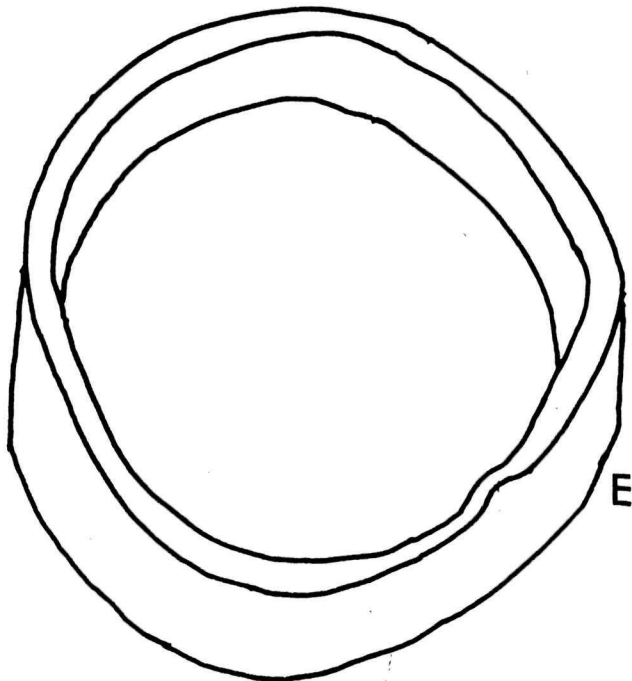
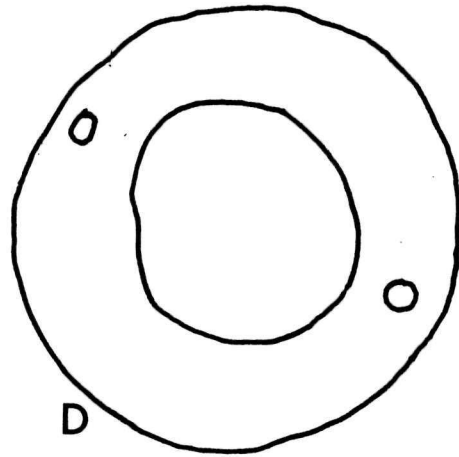
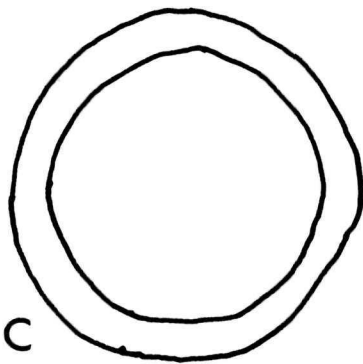
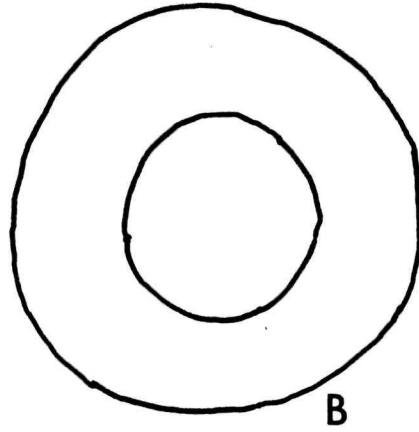
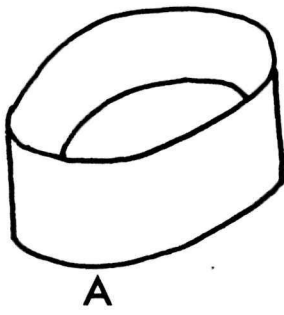

Figure 174. Nail types. (a-k) head types, (l-o)
point types.

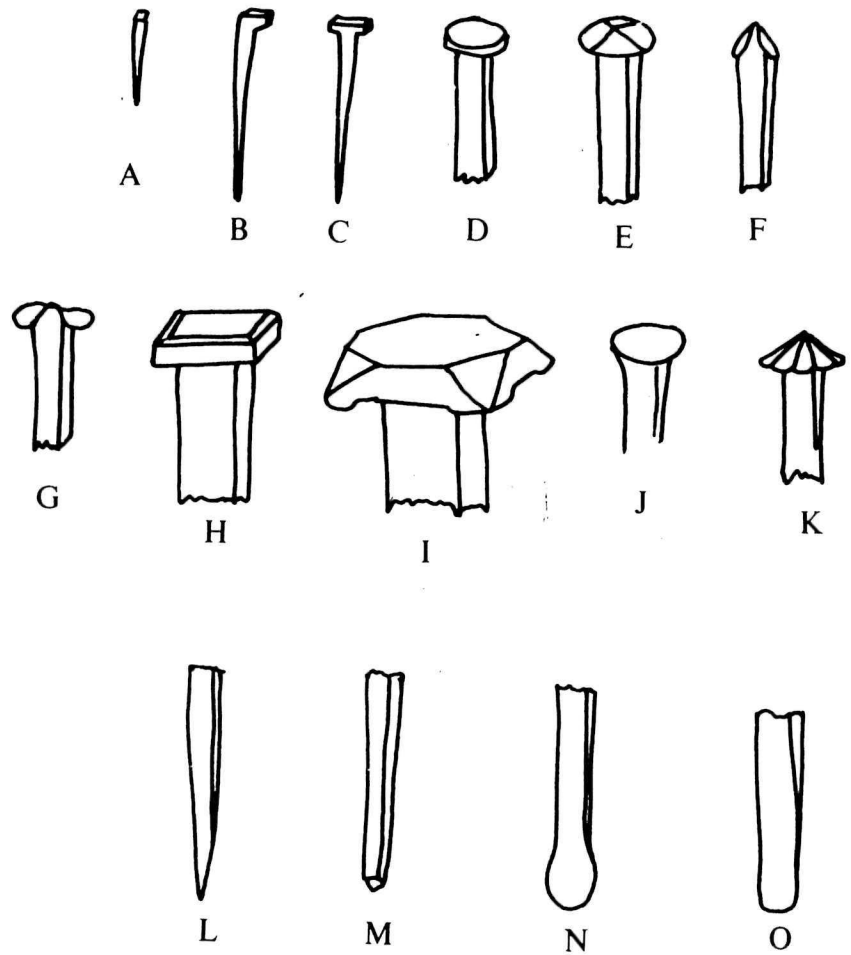

Figure 175. Diagram of nail distribution in operation
10. Total specimens, English contexts.

	E1000	E1010	E1020	E1030	E1040
N1000	4 .13	107 3.4	60 1.9	175 5.6	63 2.0
N990	21 .67	168 5.4	56 1.8	249 8.0	216 6.9
N980	7 .2	279 8.9	148 4.7	302 9.7	400 12.8
N970	9 .29	85 2.7	106 3.4	164 5.2	149 4.8
	5 .16		12 .38	16 .5	22 .7
					78 2.5
					140 4.5
					74 2.4
					8 .25

Figure 176. Diagram of **nail** distribution in operation
10. Specimens from rubble zone; probably English.

	E1000	E1010	E1020	E1030	E1040
N1000	26 2.4	4 0.35	1 0.09	5 0.45	
N990	28 2.5	24 2.2	17 7.9	75 6.9	49 4.4
N980	31 2.8	50 4.5	135 12.3	378 34.4	14 1.3
N970	35 3.2	18 1.6	68 6.2	70 6.4	
	4.36				

Figure 177. Diagram of nail distribution in operation
10. Specimens from occupational zone; probably English.

	E1000	E1010	E1020	E1030	E1040
N1000	4 0.19	81 4.0	56 2.8	174 8.6	58 2.9
N990	21 1.0	140 6.9	32 1.6	162 8.0	140 6.9
N980	7 0.3	248 12.3	98 4.8	167 8.3	22 1.1
N970	9 0.4	50 2.5	88 4.3	96 4.7	79 3.9
	1 0.05		12 0	16 0.8	22 1.1
					8 0.4

Figure 178. Diagram of nail distribution in operation
10. Specimens from occupational zone; probably
French.

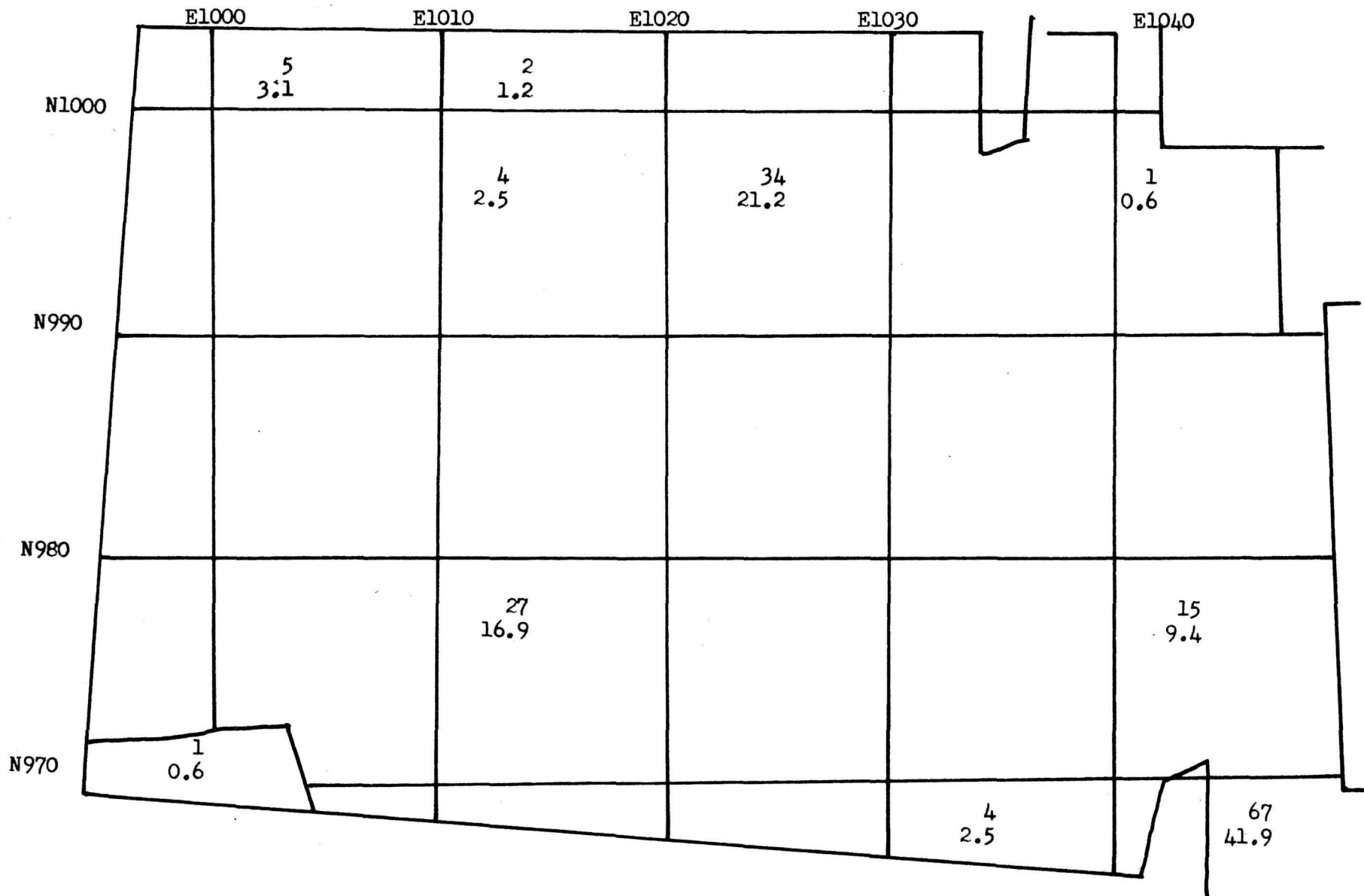
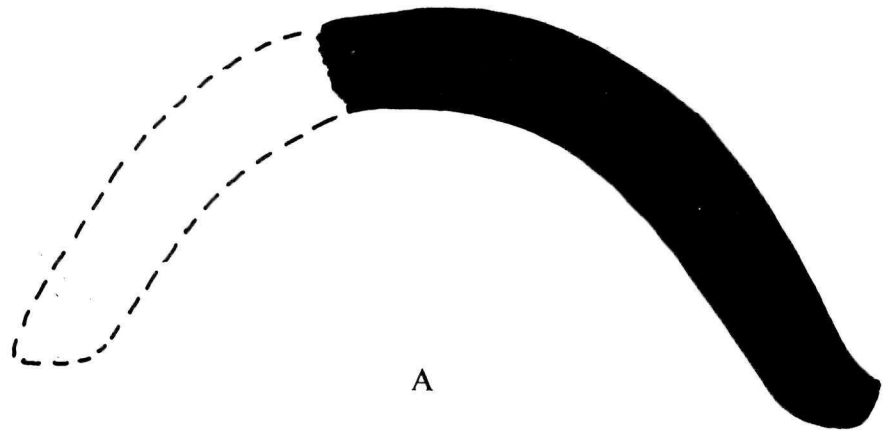
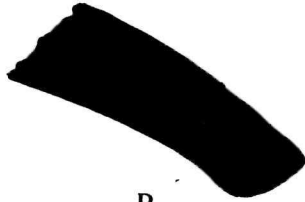

Figure 179. Cross-sections of earthenware roof tile.
(a,c) flared side, (b) straight side, (d) end. Scale
in cm.



A



B



C



D

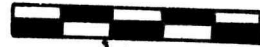

CM.

Figure 180. Diagram of basic cut stone types.

(a,b) cordon stones, (c,d) door stones, (e,f) special limestone, (e) parapet coping?, (f) arch stone?.

Field numbers: (a) 34, (b) 11, (c) 1, (d) 13, (e) 18, (f) 23. Not to scale.

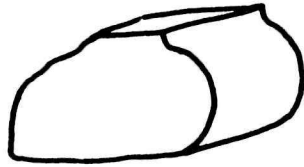

A

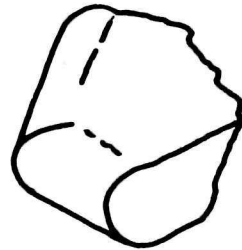

B

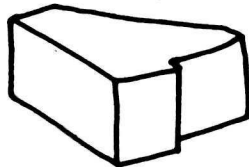

C

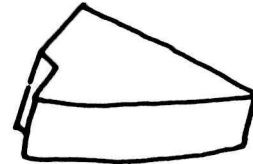

D

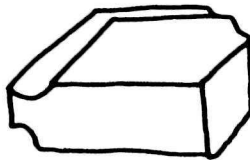

E

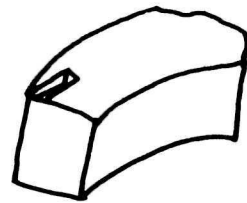

F

